

COWLES FOUNDATION FOR RESEARCH IN ECONOMICS
AT YALE UNIVERSITY

Box 2125, Yale Station
New Haven, Connecticut 06520

COWLES FOUNDATION DISCUSSION PAPER NO. 1285

Note: Cowles Foundation Discussion Papers are preliminary materials circulated to stimulate discussion and critical comment. Requests for single copies of a Paper will be filled by the Cowles Foundation within the limits of the supply. References in publications to Discussion Papers (other than mere acknowledgment by a writer that he has access to such unpublished material) should be cleared with the author to protect the tentative character of these papers.

A GRAPHICAL ANALYSIS OF SOME BASIC RESULTS IN SOCIAL CHOICE

Estelle Cantillon and Antonio Rangel

November 2000

A Graphical Analysis of Some Basic Results in Social Choice*

Estelle Cantillon
Cowles Foundation
Yale University
Estelle.Cantillon@yale.edu

Antonio Rangel
Department of Economics
Stanford University
and
NBER
and
Instituto de Análisis Económico
rangel@leland.stanford.edu

November 2000

Abstract

We use a simple graphical approach to represent Social Welfare Functions that satisfy Independence of Irrelevant Alternatives and Anonymity. This approach allows us to provide simple and illustrative proofs of May's Theorem, of variants of classic impossibility results, and of a recent result on the robustness of Majority Rule due to Maskin (1995). In each case, geometry provides new insights on the working and interplay of the axioms, and suggests new results including a new characterization of the entire class of Majority Rule SWFs, a strengthening of May's Theorem, and a new version of Maskin's Theorem.

1 Introduction

In this paper we use a simple graphical approach to represent Social Welfare Functions (SWFs) that satisfy Independence of Irrelevant Alternatives and Anonymity. Using this representation we provide new, simple and illustrative proofs of classic results in social choice like May's Theorem and variants of impossibility results like Arrow's, Wilson's and Saari's Theorems. We also use the approach to provide a new and simple proof of a recent result on the robustness of Majority Rule due to Maskin (1995).

This paper makes two contributions. The first one is pedagogical. The abstractness of social choice is due, in no small part, to the fact that it is difficult to visualize objects like the set of all binary relations satisfying certain properties. The approach used here provides a simple graphical representation for these objects. Using this geometry we

*We are indebted to Eric Maskin for his guidance during this project and to Donald Saari for his extremely useful comments. Estelle Cantillon gratefully acknowledges financial assistance from the Belgian Fonds National de la Recherche Scientifique. Antonio Rangel gratefully acknowledges financial assistance from Drew Fudenberg and the Bank of Spain.

provide new insights on the workings and interplay of the axioms that generate these well known results.

The second contribution is to use the graphical representation to derive new results. In particular, we derive (1) an axiomatic characterization for the entire class of majority rule SWFs, (2) a modified May's Theorem that provides a tighter characterization of Majority Rule, and (3) a new result on domain restrictions.

This is not the first paper to use a graphical approach to social choice. Donald Saari (1994, 1995) has made extensive and very productive use of graphics in his books *Geometry of Voting* and *Basic Geometry of Voting*. In fact, the simplex and truncated cube representations that we use are due to him. The difference between this paper and Saari's is that we use the method to address different questions. Blackorby, Donaldson and Weymark (1990) have also provided a graphical analysis of Arrow's Theorem. Their approach is based on Pareto Indifference, whereas ours is based on Anonymity. Note that in both cases, to be able to use graphs, one needs to strengthen one of Arrow's conditions.

2 A Graphical Representation of SWFs on the Simplex

Let A be the set of agents and X the set of alternatives. A preference profile for this society is a mapping $r : A \rightarrow W(X)$, where $W(X)$ is the set of all weak orderings over X .¹ A Social Welfare Function (SWF) is a function $R : D \rightarrow W(X)$ that maps preference profiles in the domain $D \subseteq W(X)^A$ into social preferences. Thus, we write $aR(r)b$ whenever, according to the SWF, a is socially at least as good as b at the profile r . Let $P(r)$ and $I(r)$ denote the strict and indifference preference relations derived from $R(r)$.

In this paper we study SWFs that satisfy Anonymity² and Independence of Irrelevant Alternatives (IIA).³ These two conditions simplify the structure of a SWF considerably and are at the core of the graphical representation that we use. In particular, together they imply that the social ranking between any two alternatives a and b , $R|_{\{a,b\}}$, is fully determined by three numbers: (1) the fraction of the population that prefers a to b , (2) the fraction that prefers b to a , and (3) the fraction that is indifferent. Let $m_r(a \succ b)$ denote the fraction of the population preferring a to b at profile r , and define $m_r(b \succ a)$ and $m_r(a \sim b)$ analogously. Since $m_r(a \succ b) + m_r(b \succ a) + m_r(a \sim b) = 1$, these three numbers can be represented as a point in the 3-dimensional simplex. This is illustrated in figure 1. We refer to the points in the simplex as reduced profiles because they contain all the information that is relevant to characterize the social ranking between a and b .

¹A weak ordering is a complete, reflexive and transitive binary relation.

²A SWF satisfies Anonymity if it is invariant to permutations of the individuals' labels; i.e., for any permutation π of A , and any profile r , we have that

$$R(r \circ \pi) = R(r).$$

³Let $r|_{\{a,b\}}$ denote the restriction of preference profile r to the pair of alternatives $\{a,b\}$. Define $R|_{\{a,b\}}$ analogously. A SWF satisfies IIA if, for any alternatives a and b , and profiles r and \hat{r} , we have that

$$r|_{\{a,b\}} = \hat{r}|_{\{a,b\}} \Rightarrow R(r)|_{\{a,b\}} = R(\hat{r})|_{\{a,b\}};$$

i.e., the social ranking between a and b depends *only* on how individuals rank these two alternatives.

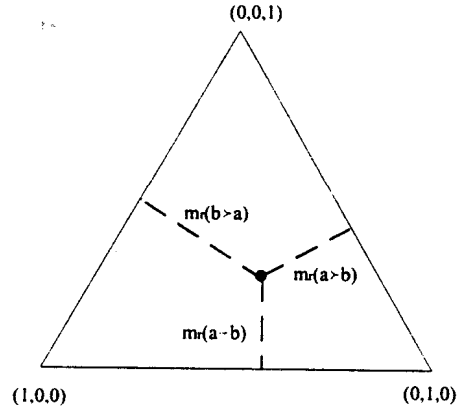

Figure 1. Graphical representation of a SWF that satisfies Anonymity and IIA

We assume that society consists of a finite number of agents. In this case, only a grid of points in the simplex corresponds to profiles in the domain of the SWF.⁴ This is illustrated in figure 2 for the case of three agents. In particular, with three agents $m_r(a \succ b)$, $m_r(b \succ a)$ and $m_r(a \sim b)$ can only take the values 0, 1/3, 2/3, or 1. For any set of agents A , let Δ_A denote the associated grid. (To simplify the graphical analysis, we omit the grid from most pictures and draw Δ_A as the entire simplex.)

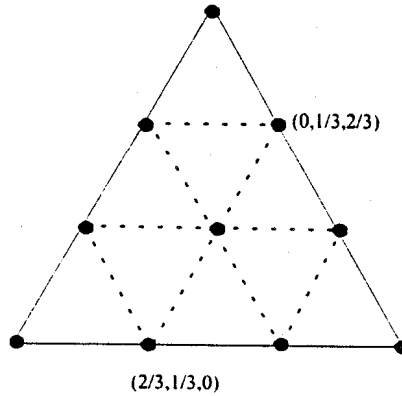

Figure 2. Domain for the case of $\#A = 3$

Summarizing, Anonymity and IIA imply that we can represent the ranking that the SWF assigns to a and b as a function of the form $R|_{\{a,b\}} : \Delta_A \rightarrow W(\{a,b\})$. As a result, $R|_{\{a,b\}}$ can be graphically represented as a partition of Δ_A into three types of regions: a region where a is socially preferred to b , a region where b is socially preferred to a , and a region where a is socially indifferent to b .

This representation, however, is still cumbersome because a full characterization of the SWF requires drawing a simplex for every pair of alternatives. In some cases it does not matter because we are only concerned about the properties of a SWF over an arbitrary

⁴ All of the arguments in the paper can easily be extended, with appropriate measurability assumptions, to the case of a continuum of agents; for example $A = [0, 1]$. In that case the entire simplex corresponds to profiles in the domain.

pair (or subset) of alternatives. In other cases Neutrality can come to the rescue.⁵ With Neutrality the name of the alternatives does not matter. This allows us to represent the entire SWF with a single simplex. To compare any two *generic* alternatives a and b , all we need to know are the numbers $m_r(a \succ b)$, $m_r(b \succ a)$ and $m_r(a \sim b)$. Furthermore, Neutrality implies that the SWF is symmetric with respect to the central axis and that a must be socially indifferent to b along that axis. This is illustrated in figure 3. The SWF on the left satisfies Neutrality, the one in the right does not.

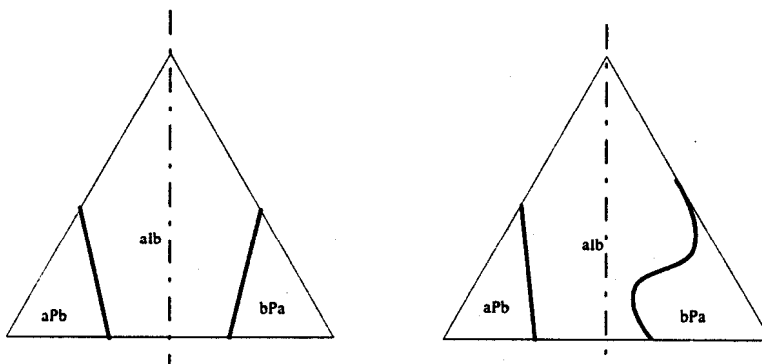

Figure 3. Examples of a SWFs that satisfies Neutrality (left) and fails Neutrality (right).

3 Monotonicity Axioms and the Geometry of Majority Rule

In a classic paper, May (1952) showed that Majority Rule is the only SWF that satisfies Neutrality, Anonymity, IIA, Positive Responsiveness (PR)⁶ and Universal Domain.⁷ However, Majority Rule is only one of a large class of SWFs that satisfy Neutrality, Anonymity, IIA, and Universal Domain. Another popular example is Strict Majority Rule.⁸ Under Strict Majority Rule, $aP(r)b$ if and only if $m_r(a \succ b) > \frac{1}{2}$. By contrast, under Majority Rule, $aP(r)b$ if and only if $m_r(a \succ b) > m_r(b \succ a)$. Figure 4 provides a graphical representation of these two SWFs.

⁵A SWF satisfies Neutrality if for any permutation ψ of the alternatives we have that

$$R(\psi \circ r) = \psi \circ R(r) ,$$

where $\psi \circ r$ is the binary relation that is obtained by changing the labels of the alternatives according to the permutation ψ .

⁶A SWF satisfies PR if for all alternatives a and b , and profiles r and \hat{r} , we have that $aP(\hat{r})b$ whenever (1) $aR(r)b$ and, for the move from r to \hat{r} , (2) a does not fall in anyone's ranking and (3) a rises in the ranking of at least one agent.

Note that with Anonymity the conditions for PR reduce to: (1) $aR(r)b$, (2) $m_{\hat{r}}(a \succ b) + m_{\hat{r}}(a \sim b) \geq m_r(a \succ b) + m_r(a \sim b)$, and (3) $m_{\hat{r}}(a \succ b) \geq m_r(a \succ b)$, with at least one of these inequalities being strict.

⁷A SWF satisfies Universal Domain if $D = W(X)^A$.

⁸In *Collective Choice and Social Welfare*, Sen discusses other variants of Majority Rule (see chapter 10.)

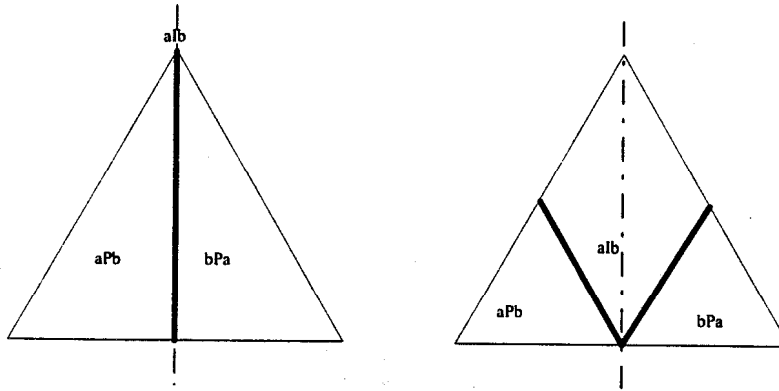

Figure 4. Majority Rule (left) and Strict Majority Rule (right)

Given all of the structure that these four axioms impose on the SWF, it is remarkable how they fail to discipline it: as long as the SWF is symmetric with respect to the vertical axis, all kinds of crazy social rankings are permitted. Figure 5 displays two extreme examples: Anti-Majority Rule, for which $aP(r)b$ if and only if $m_r(b \succ a) > m_r(a \succ b)$, and a SWF that allows for disconnected regions of indifference.

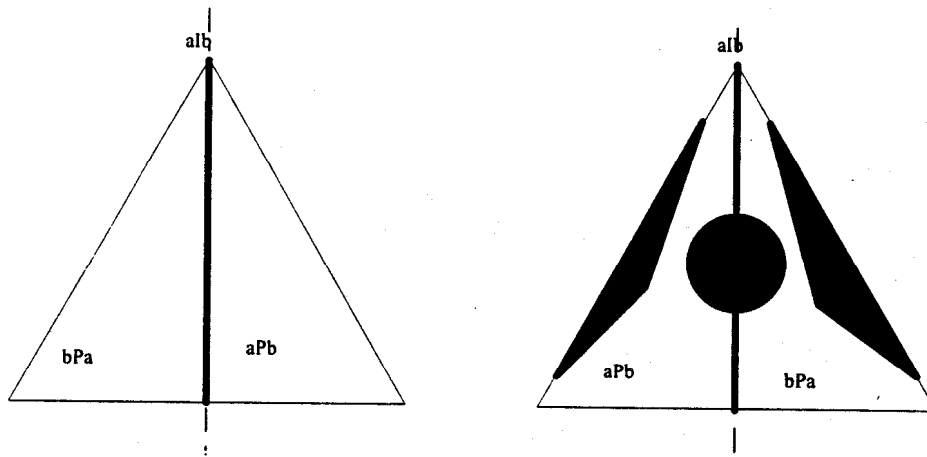

Figure 5. Examples of SWFs that satisfy Anonymity, Neutrality, and IIA

This suggests two natural questions: (1) What additional axiom or axioms are required to rule out these types of crazy SWFs? and (2) How does the additional axiom that characterizes Majority Rule differ from the ones that characterize Strict Majority Rule and other plausible SWFs? As we will see, we can give simple and intuitive answers to these questions using the graphical representation in the simplex.

What we need are additional axioms that determine what happens to social preferences when an alternative becomes more popular. Consider the following three variations on monotonicity axioms:⁹

⁹A general definition of these axioms should in principle also include the additional requirement that

STRONG *P*-MON A SWF satisfies Strong *P*-Mon if for all alternatives a and b and profiles r and \hat{r} , we that $aP(\hat{r})b$ whenever (1) $aP(r)b$, (2) $m_{\hat{r}}(a \succ b) + m_{\hat{r}}(a \sim b) \geq m_r(a \succ b) + m_r(a \sim b)$, and (3) $m_{\hat{r}}(a \succ b) \geq m_r(a \succ b)$, with at least one of these inequalities being strict.

STRONG *I*-MON A SWF satisfies Strong *I*-Mon if for all alternatives a and b and profiles r and \hat{r} , we that $aP(\hat{r})b$ whenever (1) $aI(r)b$, (2) $m_{\hat{r}}(a \succ b) + m_{\hat{r}}(a \sim b) \geq m_r(a \succ b) + m_r(a \sim b)$, and (3) $m_{\hat{r}}(a \succ b) \geq m_r(a \succ b)$, with at least one of these inequalities being strict.

WEAK *I*-MON A SWF satisfies Weak *I*-Mon if for all alternatives a and b and profiles r and \hat{r} , we that $aP(\hat{r})b$ whenever (1) $aI(r)b$, (2) $m_{\hat{r}}(a \sim b) = m_r(a \sim b)$, and (3) $m_{\hat{r}}(a \succ b) > m_r(a \succ b)$.

All of these axioms state conditions under which a must be socially strictly preferred to b when more people prefer a to b . The difference between the “*P*” version and the “*I*” version of the axioms has to do with the conditions under which the axiom bites. *P*-Mon axioms only bite if we start from a profile r at which a is socially strictly preferred to b . By contrast, *I*-Mon axioms provide conditions under which social indifference can be transformed into a strict social preference.

The difference between the strong and the weak version of the axiom is illustrated in figure 6. It has to do with what type of movements in the domain generate a strict social ranking. The axioms cover three different types of movements: (1) direction A, which occurs when one agent switches from indifference to strict preference for a , (2) direction B, which occurs when one agent switches from strict preference for b to strict preference for a , and (3) direction C, which occurs when one agent switches from strict preference for b to indifference. In the strong version of the axioms, a movement in any of these three directions guarantees a strict social ranking. In the weak version of the axiom, only a movement in direction B does.¹⁰

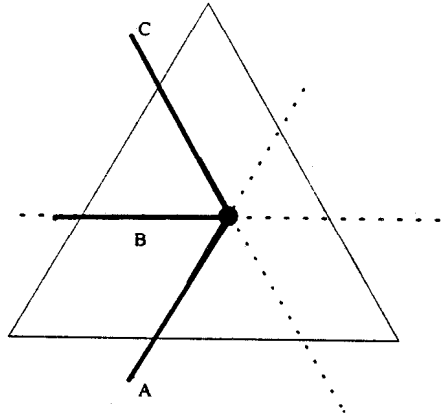

Figure 6. Illustration of monotonicity axioms

alternative a hasn't fallen in anyone's ranking (see footnote 6.) However, since this additional condition is made redundant by Anonymity, we work with the simpler version.

¹⁰Other variations of *I*-Mon and *P*-Mon are possible. For example, we could define a Monotonicity axiom that only applies to movements in the direction A.

Now consider the relationship between these axioms and Majority Rule. Using figure 4 it is easy to check that Majority Rule satisfies the three types of monotonicity. Note also that PR is equivalent to Strong P -Mon and Strong I -Mon. In fact, we can think of these two monotonicity axioms as a decomposition of PR into more elementary parts. This is interesting because it allows us to improve our understanding of the role that PR plays in May's Theorem.

MODIFIED MAY'S THEOREM *A SWF satisfies Anonymity, IIA, Neutrality, Universal Domain, and Weak I -Mon if and only if it is Majority Rule.*

Proof It is trivial to check that Majority Rule satisfies these five properties. Now, to prove that they imply Majority Rule it suffices to show that they imply the graph for Majority Rule shown in figure 4 (left). Anonymity and IIA guarantee that we can use the simplex to represent the SWF. Neutrality guarantees that one simplex is enough to fully describe the SWF. Universal Domain implies that all the points in Δ_A belong to the domain. Neutrality implies that aIb along the central axis. Finally, Weak I -Mon implies that starting from the central axis, any horizontal movement to the left generates aPb and any horizontal movement to the right generates bPa . This yields exactly the graphical characterization of Majority Rule. ■

This result provides a characterization of Majority Rule that is tighter than May's Theorem since Weak I -Mon is a weaker axiom than PR: PR implies Weak I -Mon, but as shown in figure 7, the opposite is not true. In the SWF depicted in the figure, aIb for all of the profiles on the curve, aPb to the left, and bPa to the right. Starting at point s , PR implies that a movement to r must yield $aP(r)b$, which is not the case. Thus, this SWF satisfies Weak I -Mon but not PR.

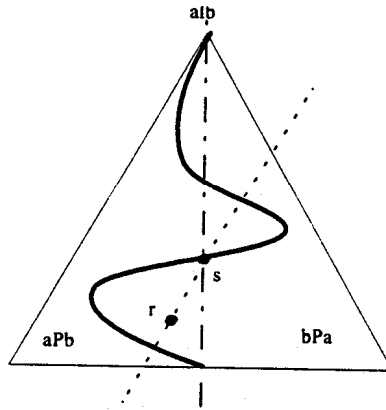

Figure 7. A SWF satisfying Weak I -Mon but not PR

The reason why we can get a tighter characterization of Majority Rule is that the difference between the three monotonicity axioms disappears when they are combined with the other axioms that characterize Majority Rule. This is easily seen graphically. Because Neutrality imposes social indifference for all the profiles on the vertical axis, Strong I -Mon and Weak I -Mon become equivalent: it does not matter that Strong I -Mon allows for more directions to break social indifference. In addition, as the proof

illustrates, once IIA, Anonymity, Universal Domain and Neutrality have been used, Weak I -Mon suffices to describe completely the SWF: Strong P -Mon is no longer necessary.

So far we have seen that Weak I -Mon is a sufficient additional axiom to characterize Majority Rule. But, what about other SWFs of interest like Strict Majority Rule? Using figure 4 it is straightforward to check that Strict Majority Rule violates Strong and Weak I -Mon. In particular, Strict Majority Rule has thick indifference sets, but Strong and Weak I -Mon imply thin indifference sets. Indeed, look at all of the points that represent profiles for which $m_r(a \sim b) = t$. This generates a horizontal line in the simplex with height t . Strong and Weak I -Mon imply that there is at most one point in the line at which a is socially indifferent to b .

This suggests that to provide an axiomatic characterization of Strict Majority Rule we need to find a monotonicity axiom that allows for thick indifference sets. Since Weak I -Mon is too strong, consider the following weaker version of the axiom:

φ WEAK I -MON Let $\varphi : [0, 1] \rightarrow [0, 1]$ such that $\varphi(t) \geq \frac{1-t}{2}$ for all t . A SWF satisfies φ -Weak I -Mon if for all alternatives a and b and all profiles r and \hat{r} , we have that $aP(\hat{r})b$ whenever (1) $aI(r)b$, (2) $m_{\hat{r}}(a \succ b) > m_r(a \succ b)$, (3) $m_{\hat{r}}(a \sim b) = m_r(a \sim b)$, and (4) $m_r(a \succ b) \geq \varphi(m_r(a \sim b))$.

φ -Weak I -Mon is identical to Weak I -Mon except that it only applies on a subset of the domain.¹¹ In particular, a horizontal movement from r to \hat{r} that raises a in the ranking of some agents (while keeping the number of indifferent people constant) is sufficient to break social indifference *only if the amount of agents who prefer a at r is large enough*: $m_r(a \succ b)$ must be greater than $\varphi(m_r(a \sim b))$.

This is illustrated in figure 8. For the φ function depicted in the figure, the axiom bites at the profile s since $m_s(a \succ b) \geq \varphi(m_s(a \sim b))$, but not at r since $m_r(a \succ b) < \varphi(m_r(a \sim b))$. Note also that for some profiles $\varphi(m_r(a \sim b))$ lies outside of the simplex. This just says that with $m_r(a \sim b)$ people indifferent between a and b , no horizontal movement that raises a in the ranking of some agents is sufficient to break social indifference.

¹¹Because φ does not depend on the alternatives under consideration, our definition of φ -Weak I -Mon introduces implicitly some Neutrality among the alternatives. However, it is easy to see how such a notion could be generalized. Furthermore, since in this paper we use φ -Weak I -Mon together with Neutrality, the distinction is unimportant.

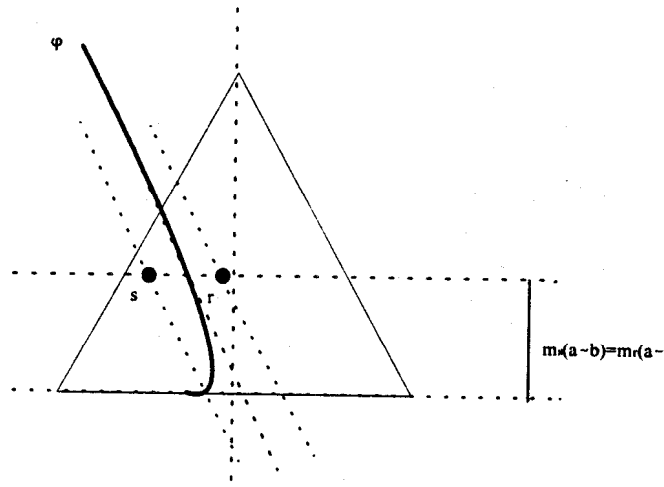

Figure 8. Illustration of φ -Weak *I*-Mon

The restriction $\varphi(t) \geq \frac{1-t}{2}$ for all t is necessary to make sure that the axiom is well defined. To see why, consider a profile for which $m_r(a \sim b) = t$. That profile lies in the vertical axis only if $m_r(a \succ b) = m_r(b \succ a) = \frac{1-t}{2}$. If $\varphi(t) < \frac{1-t}{2}$, as depicted in figure 9, the φ curve that characterizes the area where social indifference switches to social preference for a over b intersects with the right hand side of the simplex (and the other way around for the φ curve that determines social preference for b over a .) Now suppose that we have social indifference along the profiles that lie on the curve φ . Starting with the right curve, the axiom implies that at any profile to the left of A we must have aPb . Similarly, starting at the left curve, the axiom implies that at any profile to the right of B we must have bPa . Clearly, this cannot be true. As long as $\varphi(t) \geq \frac{1-t}{2}$ for all t , the curves do not cross to the other side of the simplex and the contradiction cannot arise.

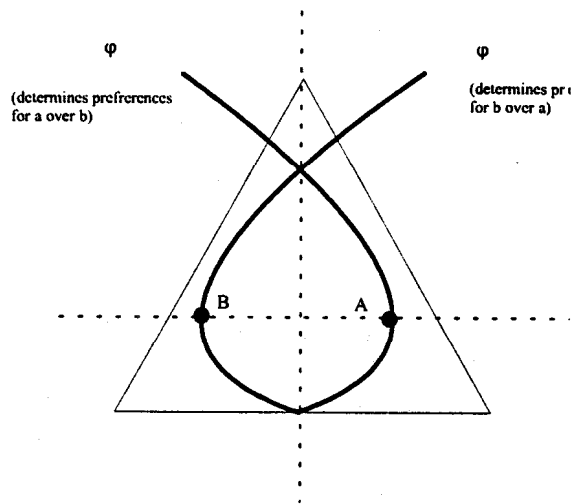

Figure 9. Illustration of φ -Weak *I*-Mon

It is easy to check from figure 4 that Strict Majority Rule satisfies φ -Weak *I*-Mon with

$\varphi(t) = \frac{1}{2}$. Nevertheless, this axiom is still not enough to fully characterize Strict Majority Rule. The problem is illustrated in figure 10, where the SWF satisfies φ -Weak *I*-Mon for $\varphi(t) = 1/2$, but is not Strict Majority Rule. The problem is that the axiom does not bite if there are no profiles r on the curve φ or to the left of it for which $aI(r)b$.

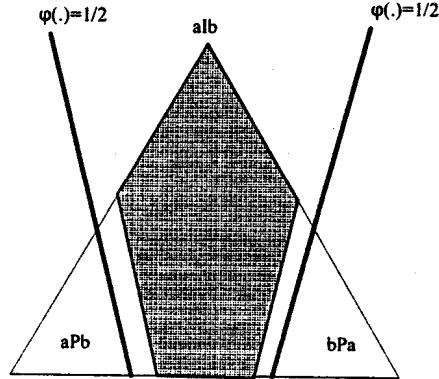

Figure 10. A SWF where φ -Weak *I*-Mon does not bite

To achieve a full characterization we need an additional axiom:

φ -INDIFFERENCE A SWF satisfies φ -Indifference if for all alternatives a and b and all profiles r , we have that $aI(r)b$ whenever (1) $m_r(a \succ b) \leq \varphi(m_r(a \sim b))$ and (2) $m_r(b \succ a) \leq \varphi(m_r(a \sim b))$, where $\varphi : [0, 1] \rightarrow [0, 1]$ and $\varphi(t) \geq \frac{1-t}{2}$ for all t .

This axiom is very intuitive. Consider the horizontal line in the simplex that corresponds to the profiles r with $m_r(a \sim b) = t$. As illustrated in figure 11, φ Indifference says that a is socially indifferent to b for all the profiles that lie between the left and right φ curves. In other words, the axiom defines an indifference set.

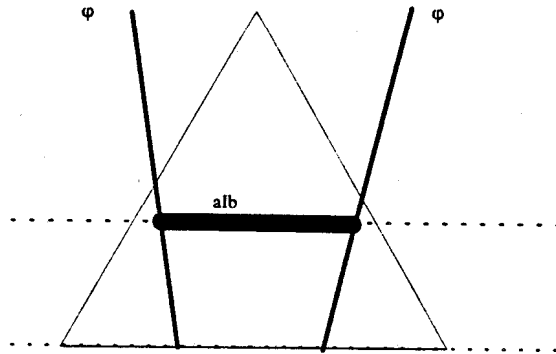

Figure 11. Illustration of φ -Indifference

The following lemma shows that adding φ -Weak *I*-Mon and φ -Indifference to our previous axioms is enough to fully characterize the SWF:

LEMMA 1 Consider a SWF that satisfies Anonymity, Neutrality, IIA, Universal Domain, φ -Weak I-Mon, and φ -Indifference. Then for all alternatives a and b and for all r ,

$$aP(r)b \Leftrightarrow m_r(a \succ b) > \varphi(m_r(a \sim b))$$

Proof As before, Anonymity, Neutrality, IIA and Universal Domain imply that we can fully characterize the SWF in the simplex. Neutrality implies that the SWF is symmetric with respect to the vertical axis and that aIb for all profiles on that axis. So consider a profile r in the left hand-side of the simplex. There are two possibilities (1) If $m_r(a \succ b) \leq \varphi(m_r(a \sim b))$, then φ -Indifference implies that $aI(r)b$. (2) If $m_r(a \succ b) > \varphi(m_r(a \sim b))$, then (1) and φ -Weak I-Mon implies that $aP(r)b$. The rest of the claim follows by symmetry. ■

Note that in order to obtain a full characterization of the SWF, the weak monotonicity and indifference axioms may have to use the same φ . Let φ_{wm} and φ_i denote the functions for the two axioms. Then, if $\varphi_{wm}(t) > \varphi_i(t)$ for all t , the SWF is not fully characterized at the profiles that lie between the two curves: social indifference and strict social preference are compatible with both axioms for those points. Thus, if the grid Δ_A is fine enough so that there are profiles that lie between the two curves, the SWF is not fully defined. On the other hand, if $\varphi_{wm}(t) < \varphi_i(t)$ for some t , the two axioms may be incompatible.

These arguments establish the following axiomatic characterization of Strict Majority Rule:

THEOREM A SWF satisfies Anonymity, Neutrality, IIA, Universal Domain, φ -Weak I-Mon, and φ -Indifference with $\varphi(x) = \frac{1}{2}$ if and only if it is Strict Majority Rule.

It might seem that the characterization of Strict Majority Rule requires the introduction of an additional axiom. This is not quite true. φ -Indifference is implicitly present in the Modified May's Theorem because, for $\varphi(t) = \frac{1-t}{2}$, Neutrality implies that φ -Indifference and Weak I-Mon is equivalent to φ -Weak I-Mon.

These axioms can also be used to provide a full and intuitive characterization of the entire class of majority based social welfare functions:

GENERALIZED MAY'S THEOREM Every majority based SWF is fully characterized by the axioms Anonymity, Neutrality, IIA, Universal Domain, φ -Weak I-Mon, and φ -Indifference.

In fact, the theorem suggests an intuitive definition of the class of majority based SWFs. A SWF belongs to the class of majority based social welfare functions if there exists a function $\varphi : [0, 1] \rightarrow [0, 1]$ with $\varphi(t) \geq \frac{1-t}{2}$ for all t such that, for all alternatives a and b and for all profiles r ,

$$aP(r)b \Leftrightarrow m_r(a \succ b) > \varphi(m_r(a \sim b)).$$

In other words, a majority based rule specifies a threshold $\varphi(t)$ such that, whenever a fraction t of the population is indifferent between a and b , a can be socially strictly preferred only if at least a fraction $\varphi(t)$ of the population strictly prefers a .

We conclude the section with a final comment about uniqueness. As illustrated in figure 12, the φ functions that characterize these SWFs are not uniquely defined. With a finite number of agents two different φ functions may characterize the same SWF.

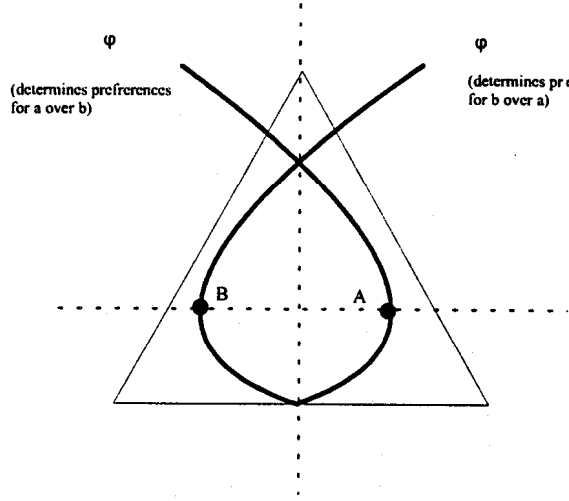

Figure 12. Characterization of SWF with a finite number of agents

4 A Graphical Representation of SWFs on the Truncated Cube

In the next two sections we study the geometry of domain restrictions and impossibility results. To do this we use another graphical representation that allows us to look at the rankings over three alternatives at a time.

We restrict attention to the class of SWFs defined over a domain $D \subseteq S(X)^A$, where $S(X)$ is the set of all possible strict orderings over X .¹² Let a, b and c be any three alternatives. As before, we will look at SWFs that satisfy *IIA* and Anonymity. This implies that the only relevant information for determining the social ranking among these alternatives is: (1) the fraction of the population that prefers a to b , (2) the fraction of the population that prefers b to c , and (3) the fraction that prefers c to a . As illustrated in figure 13, we can represent this information by a point $(m_r(a \succ b), m_r(b \succ c), m_r(c \succ a))$ that belongs to the unit cube in \mathbb{R}^3 . Alternatives a and b are compared along the x -axis, alternatives b and c are compared along the y -axis, and alternatives c and a are compared along the z -axis. For example, the vertex with coordinates $(1, 1, 0)$ represents a profile r where everyone prefers a to b , b to c and a to c . More generally, on the vertices of the unit cube all voters have the same ranking over the three alternatives. At profiles corresponding to one of the faces of the cube all the voters agree about the relative ranking over two alternatives. For example, everyone prefers b to c for profiles on the upper face.

¹²A strict ordering is a complete, antisymmetric and transitive binary relation.

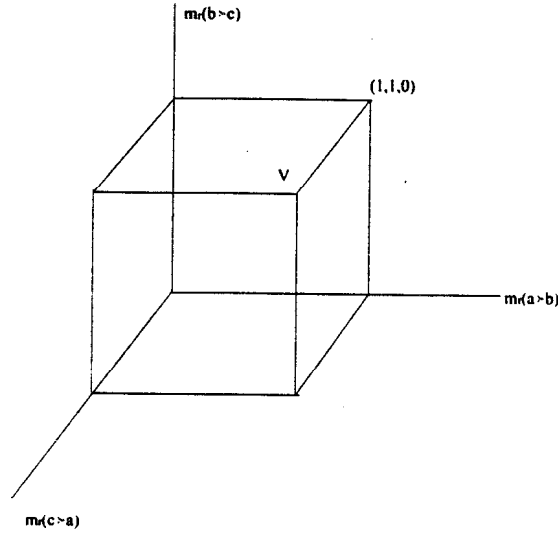

Figure 13. The unit cube

Not every point in the cube represents a valid profile in $S(X)^A$. Consider, for example, vertex V in figure 13 where everyone prefers a to b , b to c and c to a , a clear conflict with individual rationality. This suggests that the domain of any SWF is given by a *subset* of the unit cube.

Consider a profile r and suppose that $m_r(a \succ b) + m_r(b \succ c) > 1$. Then there are at least $m_r(a \succ b) + m_r(b \succ c) - 1$ agents who prefer a to c at profile r , i.e., $m_r(a \succ c) \geq m_r(a \succ b) + m_r(b \succ c) - 1$. Using the fact that $m_r(c \succ a) = 1 - m_r(a \succ c)$, this provides an upper bound to the fraction of people who prefer c to a :

$$m_r(a \succ b) + m_r(b \succ c) + m_r(c \succ a) \leq 2.$$

Similarly, if $m_r(c \succ b) + m_r(b \succ a) > 1$, then at least a fraction $m_r(c \succ b) + m_r(b \succ a) - 1$ of the agents must prefer c to a . This provides a lower bound on $m_r(c \succ a)$:

$$m_r(c \succ a) \geq m_r(c \succ b) + m_r(b \succ a) - 1.$$

Combining these two conditions we get that:

$$1 \leq m_r(a \succ b) + m_r(b \succ c) + m_r(c \succ a) \leq 2. \quad (1)$$

Condition (1) implies that the two tetrahedrons defined by the vertex V and the origin O have to be removed from the valid domain. This defines the truncated cube represented in figure 14.¹³ Note that the points on the truncated surfaces satisfy condition (1) and so belong to the truncated cube. Also, with a finite number of agents, only a grid of points corresponds to profiles in the domain. We denote this grid in the truncated cube by C_A .

¹³Saari (1994 and 1995) uses the truncated cube to represent the outcome of specific voting procedures.

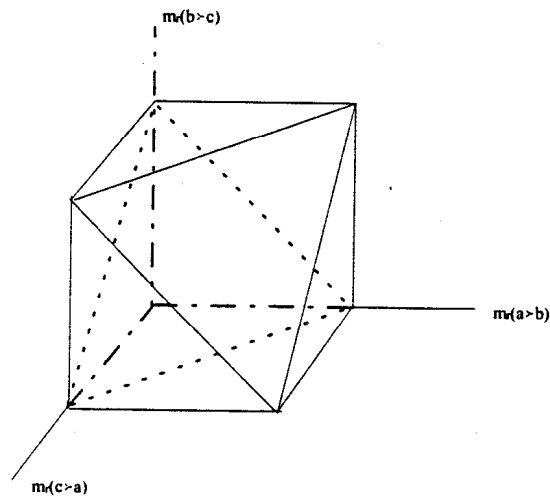
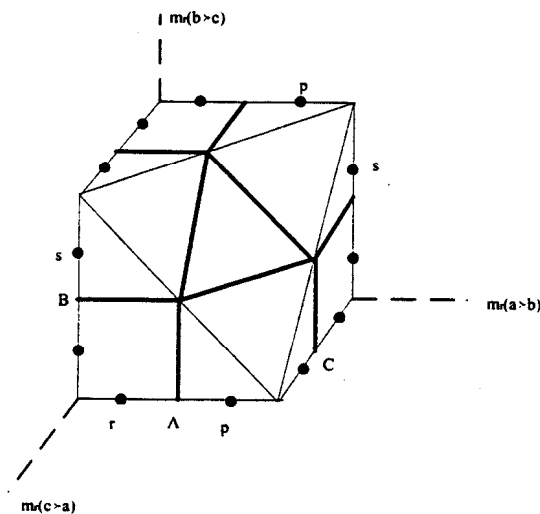

Figure 14. The truncated cube

The axioms that are commonly used in this literature have an interesting graphical representation. Universal Domain (U) says that every point in C_A represents a valid preference profile. The Pareto Property (PP)¹⁴ implies a strict social ordering between some alternatives on the faces and at the vertices. For example, on the upper face b must be socially preferred to c . IIA implies that all the profiles that lie in a plane perpendicular to the x -axis must yield the same social ranking between a and b (since $m_r(a > b)$ is the same everywhere). Similar restrictions apply for the other two axes. Finally, Neutrality implies a strong form of symmetry with respect to the center of the cube. As shown in figure 15, if aPb at the profiles represented by the point r , then bPa at the profiles represented by points p , cPb at all the profiles represented by points s , etcetera. Similarly, aIb at the profiles that lie in the plane A , bIc in the plane B , and aIc in the plane C .



¹⁴A SWF satisfies the Pareto Property if society prefers a to b whenever every individual prefers a to b .

Figure 15. Neutrality in the truncated cube

5 The Geometry of Domain Restrictions

The question of domain restrictions arises as a consequence of Arrow's famous impossibility result. It studies the possibility of escaping the result by relaxing the universal domain assumption. Let $S(X)$ be the set of all strict orderings over X . There are two ways to relax Universal Domain. First, we can restrict the set of orderings that individuals can have but not the combinations of profiles that can arise. In this case the domain restriction takes the form D^A , for some $D \subseteq S(X)$. Alternatively, we can place restrictions on the combinations of individual rankings. In this case the domain restriction takes the form $\hat{D} \subseteq S(X)^A$.

Although both approaches lend themselves to a graphical analysis in the cube, in this section we focus mostly on the first approach. Specifically, we provide a new and simple proof of a result on the robustness of Majority Rule due to Maskin (1995). We also use the truncated cube to show that Majority Rule is transitive on domains that satisfy value restriction (Sen, 1966) and to prove a new corollary of Maskin's theorem.

We start with some properties of the truncated cube that will be useful in the analysis. Let $X = \{a, b, c\}$ and consider the six vertices of the truncated cube denoted by V_i , $i = 1, \dots, 6$ (figure 16). Each vertex represents a unique profile in which all of the agents have the same preferences. Therefore, we can associate each vertex to an element of $S(X)$:

$$S(X) = \begin{cases} a \succ b \succ c & V_1 \\ c \succ a \succ b & V_2 \\ b \succ c \succ a & V_3 \\ c \succ b \succ a & V_4 \\ a \succ c \succ b & V_5 \\ b \succ a \succ c & V_6 \end{cases}.$$

Notice that V_1, V_2 and V_3 correspond to the positive Condorcet cycle $a \succ b \succ c \succ a$, and V_4, V_5, V_6 correspond to the reverse cycle $c \succ b \succ a \succ c$.

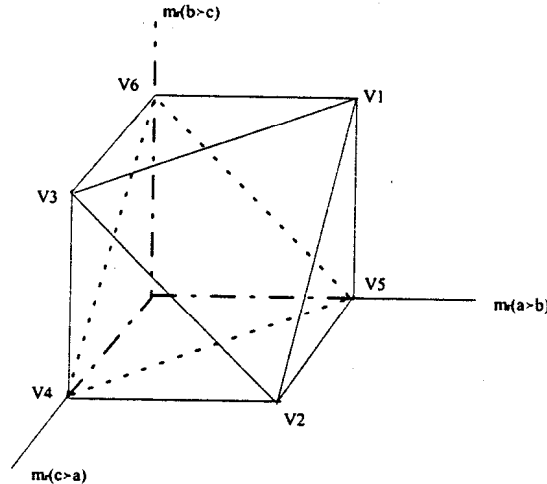

Figure 16

Now suppose that people in society can have only one of two rankings over $\{a, b, c\}$: $a \succ b \succ c$ or $b \succ c \succ a$. It is easy to check that any such profile is represented by a point on the line defined by the vertices V_1 and V_3 . More generally, take any subset D of $S(X)$. The set of all preference profiles when individual preferences are restricted to D , D^A , is represented by the convex hull of the vertices that correspond to D (modulo the grid). For example, $S(X)^A$, the set of all possible profiles for society, is represented by the convex hull (modulo the grid) of the vertices V_1, V_2, V_3, V_4, V_5 and V_6 , which is equal to the truncated cube.

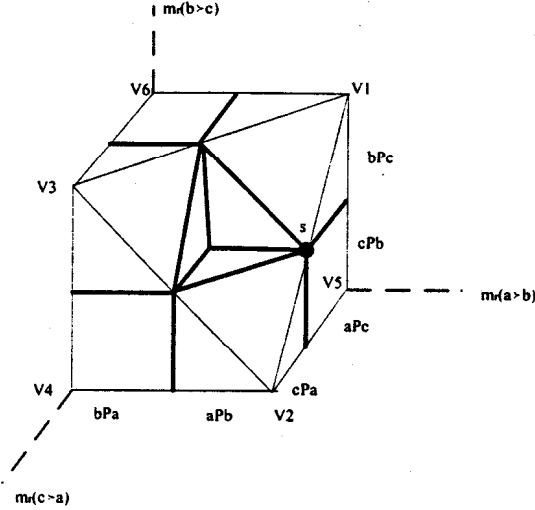

Figure 17. Majority rule in the truncated cube

Consider the graphical representation of Majority Rule in the truncated cube. Since under Majority Rule $aP(r)b \Leftrightarrow m_r(a \succ b) > m_r(b \succ a)$, this SWF divides the cube into eight (possibly truncated) quadrants as depicted in figure 17. In each one of these quadrants the social ranking is well defined. For example, in the lower-right-front quadrant aPb , cPb and cPa . It is easy to check that six of these quadrants are compatible with social transitivity, but two are not: the quadrant that has been removed (which faces the V_1, V_2, V_3 simplex), and the one that lies in the hidden corner of the cube. In other words, the domain over which Majority Rule is transitive corresponds to the profiles in the truncated cube from which these two quadrants have been removed.¹⁵ In particular, notice that domains that include profiles corresponding to the vertices V_1, V_2, V_3 and V_4, V_5, V_6 , associated with the Condorcet cycles, can be problematic for Majority Rule.

We start with a graphical proof of the following well-known result:

LEMMA 2 (Sen, 1966) *Suppose that the set of agents, A , is finite and odd. Then, Majority Rule is socially transitive on any domain $D \in S(X)$ that satisfies value restriction; i.e., on any domain D that does not contain $\{V_1, V_2, V_3\}$ or $\{V_4, V_5, V_6\}$.*

Proof First note that because there is an odd number of agents, there is no profile with $m_r(a \succ b) = \frac{1}{2}$ for any $\{a, b\}$. Next, since there are only 6 vertices, if D does not contain

¹⁵Saari (1995) shows how profiles in $S(X)^A$ can be easily retrieved from reduced profiles in C_A .

$\{V_1, V_2, V_3\}$ nor $\{V_4, V_5, V_6\}$ then $\#D \leq 4$. If $\#D = 4$, D^A generates in the cube either (1) the convex hull of a side face with a vertex on the opposite side, or (2) the convex hull of two diagonally opposite edges (like $V_4 - V_2$ and $V_1 - V_6$). In each case, it is straightforward to see that these areas do not intersect with the two quadrants where Majority Rule is not transitive. Since there is no domain D^A with $\#D = 4$ that intersects with these areas, no domain D'^A , where D' satisfies the conditions of the theorem and $\#D' < 4$, will intersect either. ■

Maskin (1995) provides the following characterization of Majority Rule. Define a *voting rule* $F : S(X)^A \rightarrow B(X)$ as a mapping from strict preference profiles to complete and reflexive (but not necessarily transitive) binary relations. A voting rule is said to be *reasonable* on a domain $D \subseteq S(X)$ if it satisfies Anonymity, Neutrality, IIA, PP and transitivity when individual preferences are restricted to D . His result reads as follows:¹⁶

THEOREM (Maskin, 1995) *Suppose that there is a finite and odd number of agents. If F is a reasonable voting rule on a domain D , then Majority Rule is also reasonable on D . Moreover, if F is not Majority Rule, then there exists a domain D' such that Majority Rule is reasonable on D' but F is not.*

We first prove the following lemma:

LEMMA 3 *Suppose that there is a finite number of agents. There exists no reasonable voting rule on D when D contains $\{V_1, V_2, V_3\}$ or $\{V_4, V_5, V_6\}$.*

Proof We consider the case where $D = \{V_1, V_2, V_3\}$. The other case is proved analogously. D^A generates the simplex V_1, V_2, V_3 in the cube (modulo the grid). The proof proceeds in three steps.

Step 1 It cannot be that $aI(r)b$ for some profile r in D^A and alternatives $\{a, b\}$.

Suppose, towards a contradiction, that $aI(r)b$ when $m_r(a \succ b) = \mu$. Consider the profile $t = (\mu, 1, 1 - \mu)$, which belongs to the line joining V_1 and V_3 . $aI(t)b$ by construction, $bP(t)c$ by PP and $aI(t)c$ by Neutrality, a contradiction of transitivity.

Step 2 We rule out any SWF that assigns the same social ranking for two or more consecutive fractions (i.e., points in the grid).

Consider the largest set of consecutive fractions such that $aP(r)b$ for all profiles with $m_r(a \succ b) \in M = \{m', m' + \frac{1}{\#A}, \dots, m'' = m' + \frac{n}{\#A}\}$ for $n \in \mathbb{N}$. By Neutrality, we can assume without loss of generality that $m' \geq \frac{1}{2}$. By Neutrality also, we also know that $bP(r)c$ for all $m_r(b \succ c) \in M$. This defines a subset of the simplex for which transitivity imposes aPc (see figure 18). But, as shown in the figure, IIA implies that this restriction must hold for stretch M' of fractions $m_r(c \succ a)$ longer than M . This contradicts the assumption that M was the longest such stretch in the first place.

¹⁶Dasgupta and Maskin (2000) generalize this result to a continuum of individuals. The proof is similar.

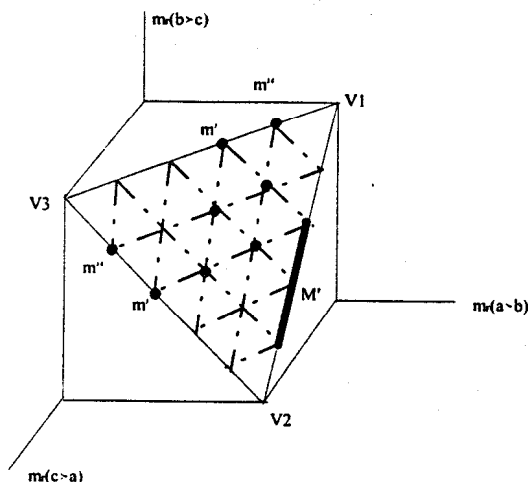

Figure 18. Proof of Lemma 2 ($n = 1$ and $\#A = 5$)

Step 3 We rule out any SWF for which the social ranking over pairs of alternatives alternates from one fraction to the other.

Let μ be a feasible fraction in $[\frac{1}{2}, 1)$ and consider the two profiles $s = (\mu, \mu, 2 - 2\mu)$ and $t = (\mu + \frac{1}{\#A}, \mu - \frac{1}{\#A}, 2 - 2\mu)$. Since the sum of the coordinates in each case is equal to two, these two profiles belong to the V_1, V_2, V_3 simplex. Without loss of generality we can assume that $aP(r)b$ for $m_r(a \succ b) = \mu$ (otherwise relabel the alternatives.) Then, by Neutrality, $aP(s)b$ and $bP(s)c$, and by transitivity $aP(s)c$. Since the social ranking alternates from one consecutive fraction to the next, $aP(r)b$ for $m_r(a \succ b) = \mu$ also implies that $bP(t)a$ and $cP(t)b$, so $cP(t)a$ by transitivity. This contradicts IIA. ■

This allows us to prove Maskin's theorem:

Proof The first part is straightforward. Suppose that F is a reasonable voting rule on a domain D . By Lemma 3, D does not contain $\{V_1, V_2, V_3\}$ or $\{V_4, V_5, V_6\}$. Lemma 2 then implies that Majority Rule is transitive, and thus reasonable on D .

To prove the second part consider the domain $D' = \{V_2, V_3, V_4\}$ which generates the front face of the truncated cube. By lemma 2, we know that Majority Rule is reasonable on this domain. Since F is not majority rule, there exists $\mu < 1/2$ such that $aR(r)b$ at all profiles r with $m_r(a \succ b) = \mu$. By Neutrality, $bR(r)c$ at all profiles r with $m_r(b \succ c) = \mu$. Now consider the profile $s = (\mu, \mu, 1)$ which belongs to the front face of the truncated cube. By construction, $aR(s)b$ and $bR(s)c$, so by social transitivity $aR(s)c$. This contradicts the PP. Thus, F cannot be reasonable on D' .

The first part is straightforward. Suppose that F is a reasonable voting rule on a domain D . By Lemma 3, D does not contain $\{V_1, V_2, V_3\}$ or $\{V_4, V_5, V_6\}$. Lemma 2 then implies that Majority Rule is transitive, and thus reasonable on D . To prove the second part consider the domain $D' = \{V_2, V_3, V_4\}$ which generates the front face of the truncated cube. By lemma 2, we know that Majority Rule is reasonable on this domain. Since F is not majority rule, there exists $\mu < 1/2$ such that $aR(r)b$ at all profiles r with $m_r(a \succ b) = \mu$. By Neutrality, $bR(r)c$ at all profiles r with $m_r(b \succ c) = \mu$. Now consider the profile $s = (\mu, \mu, 1)$ which belongs to the front face of the truncated cube. By

construction, $aR(s)b$ and $bR(s)c$, so by social transitivity $aR(s)c$. This contradicts the PP. Thus, F cannot be reasonable on D' . ■

The geometry exploited in the second part of the proof suggests an interesting corollary to Maskin's Theorem. In particular, the second part of the proof shows that Majority Rule is the *only* reasonable SWF in a any domain that satisfies value restriction and includes a complete face of the truncated cube. By contrast, if the domain does not include a complete face, there may be other reasonable SWFs. Consider, for example, $D = \{V_1, V_3, V_4, V_5\}$ that defines a plane that cuts the truncated cube diagonally from top to bottom. It easy to check that 2/3 Majority Rule is reasonable in this domain.

COROLLARY *Suppose that there is a finite and odd number of agents. Then Majority Rule is the unique reasonable voting rule on any domain that satisfies value restriction and contains a complete face of the truncated cube (modulo the grid.)*

Proof By lemma 2 we know that majority rule is reasonable on these domains. Uniqueness follows directly from the second part of the proof of the previous theorem. ■

The argument in the second part of the proof also illustrates the role that $\#A$ odd plays in the result. With an even number of agents then the profile $s = (1, 1/2, 1/2)$ depicted in figure 17 belongs to the domain. By neutrality, at that point we must have that bIc and aIc . Transitivity implies that aIc , which violates the PP since s lies in the right face of the cube. Thus, there is no reasonable SWF defined on the face of the cube with an even number of agents.

A natural question is whether the uniqueness result in the previous corollary holds only on the faces of the cube. In this case the second part of Maskin's Theorem would be driven by an arbitrarily small subset of the domain. (In fact, in the limit with a continuum of agents it would be driven by a set of measure zero.)

To see this consider the class of Majority Rule SWFs in the domain $S(X)^A$. By the Generalized May's Theorem developed in section 3, each SWF in this class is fully characterized by a number $\varphi' \in [1/2, 1)$ that denotes the threshold required to turn social indifference into strict social preference.¹⁷ The SWFs are represented in figure 20. It is easy to check that the SWF is transitive everywhere except for the darkened volumes in the center of the faces of the cube. For example, transitivity is violated in the front dark area since under φ Majority Rule we must have cIb , bIa , and cPa . However, for φ close to 1 (Unanimity) or for φ close to 1/2 (Majority Rule) the volume of these areas shrinks to almost zero, and to a set of measure zero in the limit case of a continuum of voters.¹⁸ This suggests that Majority Rule is the unique reasonable SWF in an arbitrarily small part of the domain.

¹⁷Since individual indifference is not allowed, we only need to characterize the SWF at the base of the simplex; i.e., $\varphi' \equiv \varphi(0)$.

¹⁸Figure illustrates a related result by Balasko and Cres (1997) who have studied how the transitivity of super majority rule changes with the threshold φ of the super majority. They show that Condorcet cycles become rare events for super majority rules larger than 53%.

Now consider any two profiles represented by $s = (\mu^*, 1, \mu^*)$ and $t = (0, 1 - \mu^*, \mu^*)$. The two profiles satisfy condition (1) and thus, as depicted in figure 20, they belong to the truncated cube. Also, since they lie in the same plane (defined by $m_r(c \succ a) = \mu^*$), IIA implies that the social ranking between a and c must be the same at both points. But at s , $aR(s)b$ by definition of μ^* and PP implies that $bP(s)c$. Thus, $aP(s)c$. Similarly, at t $cP(t)b$, since it belongs to the horizontal plane, and $bP(t)a$ by the PP. Thus, $cP(t)a$ - a contradiction.

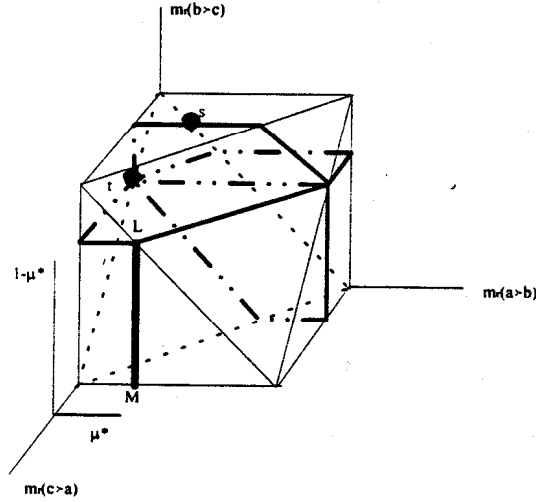

Figure 20. Graphical illustration of Arrow's Theorem

Arrow's celebrated result has been revisited many times and several alternative proofs have been provided, including very short ones like those recently proposed by Geanakoplos (1996). The value of our proof is that it allows us to visualize how much structure is actually imposed by the combination of IIA and transitivity of social preferences, and how the axioms interact to produce the result.

Notice, in particular, that PP is barely needed in the proof: it is used to define μ^* and in the last step when it comes to identifying profiles for which bPc and bPa . This suggests that a relaxation of PP is possible. Two alternatives have been explored in the literature:

Weak Involvement (Weak INV) For each pair of alternatives $\{a, b\}$, there exist profiles, r and r' , such that $aR(r)b$ and $bR(r')a$.

Involvement (INV) For each triplet $\{a, b, c\}$, there exist at least two pairs of alternatives for which the SWF is "onto." (A SWF is "onto" for the pair $\{a, b\}$ if there are profiles r and r' in the domain such that $aP(r)b$ and $bP(r')a$.¹⁹

Wilson (1972) finds that Weak INV combined with IIA and U leaves the possibility for a dictatorship, a reverse dictatorship²⁰ or a null SWF.²¹ Saari (1991) finds that INV combined with IIA and U only leaves room for a dictatorship or a reverse dictatorship.

¹⁹We could also require that there exists a profile r'' for which $aI(r'')b$, but this is not necessary.

²⁰In a reverse dictatorship, the social outcome is exactly the opposite of the dictator's strict preferences.

²¹A SWF is null if $aI(r)b$ for all a, b and all r in its domain.

Since Saari's *INV* condition only constraints social preferences along two dimensions, this conditions seem weaker than Wilson's Weak *INV*. However, it is easy to prove that, when combined with *IIA* and *U*, Saari's condition implies Wilson's. This shows that Wilson's and Saari's Theorems are closely related. Formally,

LEMMA 4 *If a SWF satisfies U, IIA and INV, then it is "onto" for any triplet of alternatives {a, b, c}.*

Proof Suppose, towards a contradiction, that $cP(r)a$ at all profiles r in the domain. By *INV*, there exist profiles r' and r'' such that $aP(r')b$ and $bP(r'')c$. Consider a third profile r^* such that $r^*|_{\{a,b\}} = r'|_{\{a,b\}}$ and $r^*|_{\{b,c\}} = r''|_{\{b,c\}}$. By *U*, r^* belongs to the domain. By *IIA* and transitivity, $aP(r^*)c$. A contradiction. ■

Using this fact, the truncated cube can also be used to provide a simple proof of this extension of Arrow's theorem, with the caveat, of course, that we impose Anonymity rather than Non-Dictatorship. Since Anonymity rules out dictatorships and reverse dictatorship, and *INV* rules out Wilson's null SWF, the impossibility result takes the following form:

WILSON's and SAARI's THEOREM (with Anonymity) *If there is a finite number of voters and at least three alternatives, then there is no SWF satisfying U, IIA, Anonymity and INV.*

Proof Consider any set of three alternatives $\{a, b, c\}$. By *U*, the truncated cube C_A represents all the possible preference profiles over these alternatives. As in the proof of Arrow's Theorem, the strategy of the proof is to construct two profiles for which the social ranking over a and c conflicts.

Suppose that there are fractions μ_{ab} , μ_{ba} , μ_{bc} and μ_{cb} such that $aP(r)b$ when $m_r(a \succ b) = \mu_{ab}$, $bR(r)a$ when $m_r(b \succ a) = \mu_{ba}$, $bP(r)c$ when $m_r(b \succ c) = \mu_{bc}$, and $cR(r)b$ when $m_r(b \succ c) = \mu_{cb}$. Now consider two profiles of the form $s = (\mu_{ab}, \mu_{bc}, x)$ and $t = (\mu_{ba}, \mu_{cb}, x)$. If the profiles belong to C_A we are done since, by construction, $aP(s)b$ and $bP(s)c$ and hence by transitivity $aP(s)c$. Similarly, $bR(t)a$ and $cR(t)b$ hence $cR(t)a$, which contradicts *IIA* since $m_s(a \succ c) = m_t(a \succ c)$.

Thus, to conclude the proof we need to show that there are fractions μ_{ab} , μ_{ba} , μ_{bc} , μ_{cb} , and x such that the two profiles belong to C_A , that is:

$$1 \leq \mu_{ab} + \mu_{bc} + x \leq 2 \tag{3}$$

$$1 \leq \mu_{ba} + \mu_{cb} + x \leq 2 \tag{4}$$

Consider all possible fractions of the population $\{0, \frac{1}{\#A}, \dots, \frac{\#A-1}{\#A}, 1\}$. By *U*, these values correspond to possible values of $m_r(a \succ b)$ for r in the domain. By *INV*, starting from $m_r(a \succ b) = 0$ and moving up along these fractions, the social ordering over a and b must be switching at some point from aPb to bRa (or the other way round). Hence, μ_{ab} and μ_{ba} can be chosen within $\frac{1}{\#A}$ of each other. The same reasoning applies for μ_{bc} and μ_{cb} . Therefore, the difference between $\mu_{ab} + \mu_{bc}$ and $\mu_{ba} + \mu_{cb}$ is of at most $\frac{2}{\#A}$. This means that there exists x that satisfies both (3) and (4). ■

A comparison of the two proofs highlights the relative roles of PP and its weaker counterpart, *INV*. In both cases the proof is centered around a violation of *IIA*. In particular,

the strategy is to show that there is a plane defined by $m_r(c \succ a) = \text{constant}$ and two profiles that lie in that plane with different social rankings over a and c . In Arrow's proof PP is used to guarantee the existence of the plane and the profiles. But clearly *INV* is enough.

References

- [1] Arrow, K. [1963] *Social Choice and Individual Values*, 2nd. edn., New York: Wiley.
- [2] Balasko, Y. and H. Cres [1997] "The Probability of Condorcet Cycles and Super Majority Rules," *Journal of Economic Theory*, (75): 237–270.
- [3] Blackorby, C., D. Donaldson and J. Weymark [1990] "A Welfarist Proof of Arrow's Theorem," *Recherches Economiques de Louvain*, (56): 256–289.
- [4] Dasgupta, P. and E. Maskin [2000], "On the Robustness of Majority Rule," manuscript.
- [5] Geanakoplos, John [1996], Three Brief Proofs of Arrow's Impossibility Theorem, Cowles Discussion Paper 1123R, Yale University.
- [6] Maskin, E. [1995] "Majority Rule, Social Welfare Functions and Game Forms", in: Basu, Pattanaik and Suzumura (eds), *Choice, Welfare and Development*, Oxford University Press, 100–109.
- [7] May, K. [1952] "A Set of Independent Necessary and Sufficient Conditions for Simple Majority Decision." *Econometrica* (20): 680–684.
- [8] Saari, D. [1991], "Calculus and Extensions of Arrow's Theorem", *Journal of Mathematical Economics*, 20, 271–306.
- [9] Saari, D. [1994] *Geometry of Voting*. Springer–Verlag.
- [10] Saari, D. [1995] *Basic Geometry of Voting*. Springer-Verlag.
- [11] Sen, A. [1966], "A Possibility Theorem on Majority Decisions", *Econometrica* (34) 2: 491–499.
- [12] Sen, A. [1970] *Collective Choice and Social Welfare*. San Francisco: Holden-Day Inc.
- [13] Wilson, R. [1972] "Social Choice Theory without the Pareto Principle," *Journal of Economic Theory*, 5, 478–486.