

# Collateral Shortages, Asset Price and Investment Volatility with Heterogeneous Beliefs\*

Dan Cao<sup>†</sup>

Department of Economics, MIT  
JOB MARKET PAPER

## Abstract

The recent economic crisis highlights the role of financial markets in allowing economic agents, including prominent banks, to speculate on the future returns of different financial assets, such as mortgage-backed securities. This paper introduces a dynamic general equilibrium model with aggregate shocks, potentially incomplete markets and heterogeneous agents to investigate this role of financial markets. In addition to their risk aversion and endowments, agents differ in their beliefs about the future aggregate states of the economy. The difference in beliefs induces them to take large bets under frictionless complete financial markets, which enable agents to leverage their future wealth. Consequently, as hypothesized by Friedman (1953), under complete markets, agents with incorrect beliefs will eventually be driven out of the markets. In this case, they also have no influence on asset prices and real investment in the long run. In contrast, I show that under incomplete markets generated by collateral constraints, agents with heterogeneous (potentially incorrect) beliefs survive in the long run and their speculative activities drive up asset price volatility and real investment volatility permanently. I also show that collateral constraints are always binding even if the supply of collateralizable assets endogenously responds to their price. I use this framework to study the effects of different types of regulations and the distribution of endowments on leverage, asset price volatility and investment. Lastly, the analytical tools developed in this framework enable me to prove the existence of the recursive equilibrium in Krusell and Smith (1998) with a finite number of types. This has been an open question in the literature.

## 1 Introduction

The events leading to the financial crisis 2007-2008 have highlighted the importance of belief heterogeneity and how financial markets also create opportunities for agents with different

---

\*I am grateful to Daron Acemoglu and Ivan Werning for their infinite support and guidance during my time at MIT. I wish to thank Guido Lorenzoni and Robert Townsend for their advice since the beginning of this project, thank George-Marios Angeletos, Ricardo Caballero, Dave Donaldson, and MIT Macro seminar, Macro Lunch, Theory Lunch, International Breakfast participants for helpful comments and discussions.

<sup>†</sup>Email: dancao@mit.edu

beliefs to leverage up and speculate. Several investment and commercial banks invested heavily in mortgage-backed securities, which subsequently suffered large declines in value. At the same time, some hedge funds profited from the securities by short-selling them.

One reason for why there has been relatively little attention, in economic theory, paid to heterogeneity of beliefs and how these interact with financial markets is the *market selection hypothesis*. The hypothesis, originally formulated by Friedman (1953), claims that in the long run, there should be limited differences in beliefs because agents with incorrect beliefs will be taken advantage of and eventually be driven out the markets by those with the correct belief. Therefore, agents with incorrect beliefs will have no influence on economic activity in the long run. This hypothesis has recently been formalized and extended in recent work by Blume and Easley (2006) and Sandroni (2000). However these papers assume financial markets are complete and this assumption plays a central role in allowing agents to pledge all their wealth.

In this paper, I present a dynamic general equilibrium framework in which agents differ in their beliefs but markets are endogenously incomplete because of collateral constraints. Collateral constraints limit the extent to which agents can pledge their future wealth and ensure that agents with incorrect beliefs never lose so much as to be driven out of the market. Consequently all agents, regardless of their beliefs, survive in the long run and continue to trade on the basis of those heterogeneous beliefs. This leads to additional leverage and asset price volatility (relative to a model with homogeneous beliefs or relative to the limit of the complete markets economy).

The framework introduced in this paper also enables a comprehensive study of how the survival of heterogeneous beliefs and the structure of financial markets affect investment in the long run. I also use this framework for studying the impact of different types of regulations on welfare, asset price volatility and investment. The dynamic general equilibrium approach adopted here is central for many of these investigations. Since it permits the use of well specified collateral constraints, it enables me to look at whether agents with incorrect beliefs will be eventually driven out of the market. It allows leverage and endogenous investment (supply of assets) and it enables me to characterize the effects of different types of policies on welfare and economic fluctuations.

The dynamic stochastic general equilibrium model with incomplete markets I present in this paper is not only useful for the analysis of the effects of heterogeneity in the survival of agents with different beliefs, but also nests well-known models as special cases, including recent models, such as those in Kubler and Schmedders (2003), Fostel and Geanakoplos (2008) and Geanakoplos (2009), as well as more classic models including those in Kiyotaki and Moore (1997) and Krusell and Smith (1998). For instance, this model allows for capital accumulation with adjustment costs in the same model in Krusell and Smith (1998) and shows the existence of a recursive equilibrium. This equilibrium existence has been an open question in the literature. The generality is useful in making this framework eventually applicable to a range of questions on the interaction between financial markets, heterogeneity, investment and aggregate activity.

More specifically, I study an economy in dynamic general equilibrium with aggregate shocks and heterogeneous, infinitely-lived agents. Aggregate shocks follow a Markov process. Consumers differ in terms of their beliefs on the transition matrix of the Markov process (for simplicity, these beliefs differences are never updated as there is no learning; in other words

agents in this economy agree to disagree).<sup>1</sup> There is a unique final good used for consumption and investment, and several real and financial assets. There are two classes of real assets: one class of assets, which I call trees, are in fixed supply and the other class of assets are in elastic supply. Only assets in elastic supply can be produced using the final good. The total quantity of final good used in the production of real assets is the aggregate *real investment*. I assume that agents cannot short sell either type of the assets. Assets in elastic supply are important to model real investment and also to show that collateral constraints do not arise because of artificially limited supply of assets.

Incomplete (financial) markets are introduced by assuming that all loans have to use financial assets as collateralized promises as in Geanakoplos and Zame (2002). Selling a financial asset is equivalent to borrowing and in this case agents need to put up some real assets as collateral. Loans are non-recourse and there is no penalty for defaulting. Consequently, whenever the face value of the security is higher than the value of its collateral, the seller of the security can choose to default without further consequences. In this case, security buyer seizes the collateral instead of receiving the face value of the security. I refer to equilibria of the economy with these financial assets as *incomplete markets equilibria* since the presence of collateral constrains introduces endogenous incomplete markets. Several key results involve the comparison of incomplete markets equilibria to the standard competitive equilibrium with complete markets.

Households (consumers) can differ in many aspects, such as risk-aversion and endowments. Most importantly they differ in their beliefs concerning the transition matrix governing transitions across aggregate states. Given the consumers' subjective expectations, they choose their consumption and real and financial asset holdings to maximize their intertemporal expected utility. In particular, the consumers' perceptions about the future value of each unit of real asset, including future rental prices and future resale value, determine the consumers' demand for new units of real assets. This demand, in turn, determines how many new units of real assets are produced. Hence, demand determines real investment in a fashion similar to the neoclassical Tobin's Q theory of investment.

The framework delivers several results. The first set of results, already mentioned above, is related to the survival of agents with incorrect beliefs. As in Blume and Easley (2006) and Sandroni (2000), with perfect complete markets, in the long run, only agents with correct beliefs survive. Their consumption is bounded from below by a strictly positive number. Agents with incorrect beliefs see their consumption go to zero, as uncertainties realize. However, in any incomplete markets equilibrium, every agent survives because of no-default-penalty condition. When agents lose their bets, they can just simply walk away from their collateral while keeping their current and future endowments. They cannot do so under complete markets because they can commit to delivering all their future endowments.

More importantly, the survival or disappearance of agents with incorrect beliefs affects asset price volatility. To focus on asset price volatility, I consider economies with only trees as real assets. Under complete markets, agents with incorrect beliefs will eventually be driven out of the markets in the long run. The economies converge to economies with homogeneous

---

<sup>1</sup>Alternatively, one could assume that even though agents differ with respect to their initial beliefs, they partially update them. In this case, similar results would apply provided that the learning process is sufficiently slow (which will be the case when individuals start with relatively firm priors)

beliefs, i.e., the correct beliefs. Markets completeness then implies that asset prices in these economies are independent of past realizations of aggregate shocks. In addition, asset prices are the net present discounted values of the dividend processes, with appropriate discount factors. As a result, asset price volatility is proportional to the volatility of dividends if the aggregate endowment, or equivalently the equilibrium stochastic discount factor, only varies by a limited amount over time and across states. These properties no longer hold under incomplete markets. Given that agents with incorrect beliefs survive in the long run, they exert permanent influence on asset prices. Asset prices are not only determined by the aggregate shocks as in the complete markets case, but also by the evolution of the wealth distribution across agents. This also implies that asset prices are history-dependent as the realizations of past aggregate shocks affect the current wealth distribution. The additional dependence on the wealth distribution raises asset price volatility under incomplete markets above the volatility level under complete markets.

I establish this result more formally using a special case in which the aggregate endowment is constant and the dividend processes are I.I.D. Under complete markets, asset prices are asymptotically constant. In contrast, asset price volatility, therefore, goes to zero in the long run. Asset price volatility stays well above zero under incomplete markets as the wealth distribution changes constantly, and asset price depends on the wealth distribution. Although this example is extreme, numerical simulations show that its insight carries over to less special cases. In general, long-run asset price volatility is higher under incomplete markets than under complete markets.

The volatility comparison is different in the short run, however. Depending on the distribution of endowments, short run asset price volatility can be greater or smaller under complete or incomplete markets. This happens because the wealth distribution matters for asset prices under both complete markets and incomplete markets in the short run. This formulation also helps clarify the long-run volatility comparison. In the long run, under complete markets, the wealth distribution becomes degenerate as it concentrates only on agents with correct beliefs. In contrast, under incomplete markets, the wealth distribution remains non-degenerate in the long run and affects asset price volatility permanently. However, the wealth of agents with incorrect beliefs may remain low as they tend to lose their bets. Strikingly, under incomplete markets and when the set of actively traded financial assets is endogenous, the poorer the agents with incorrect beliefs are, the more they leverage to buy assets. High leverage generates large fluctuations in their wealth, and as a consequence, in asset prices.

The results concerning volatility of asset prices also translate into volatility of real investment. Consequently, real investment under incomplete markets exhibits higher volatility than under complete markets. To illustrate this result, I choose a special case in which the aggregate endowment and productivity are constant over time. Under complete markets, as economies converge to economies with homogeneous beliefs, capital levels converge to their steady-state levels. Investments are therefore approximately constant; investment volatility is approximately zero. In contrast, under incomplete markets investment volatility remains strictly positive because it depends on the wealth distribution and the wealth distribution constantly changes as aggregate shocks hit the economies.

It is also useful to highlight the role of dynamic general equilibrium for some results mentioned above. In particular, the infinite horizon nature of the framework allows a com-

prehensive analysis of short-run and long-run behavior of asset price volatility. Such an analysis is not possible in finite horizon economies, including Geanakoplos's important study on the effects of heterogeneous beliefs on leverage and crises. For example, in page 35 of Geanakoplos (2009), he observes similar volatility as the economy moves from incomplete to complete markets. In my model, the first set of results described above shows that the similarity holds only in the short run. The long run dynamics of asset price volatility totally differs from complete to incomplete markets. In my model, the results are also based on insights in Blume and Easley (2006) and Sandroni (2000) regarding the disappearance of agents with incorrect beliefs. However, these authors do not focus on the effect of their disappearance on asset price or asset price volatility.

The second set of results that follow from this framework concerns collateral shortages. I show that collateral constraints will eventually be binding for every agent in complete markets equilibrium provided that the face values of the financial assets with collateral span the complete set of state-contingent Arrow-Debreu securities. Intuitively, if this was not the case, the unconstrained asset holdings would imply arbitrarily low levels of consumption at some state of the world for every agent, contradicting the result that consumption is bounded from below. In other words, there are always shortages of collateral even if I allow for an elastic supply of collateral. This result sharply contrasts with those obtained when agents have homogenous beliefs but still have reasons to trade due to differences in endowments or utility functions. In these cases, if the economy has enough collateral, or can produce it, then collateral constraints may not bind and the complete markets allocation is achieved. Heterogeneous beliefs, therefore, guarantee collateral shortages.

Another immediate implication of these results concerns Pareto inefficiency of incomplete markets equilibria. Incomplete markets equilibria are Pareto-suboptimal whenever agents strictly differ in their beliefs. This can be seen for the results that under complete markets equilibria, some agent's consumption will come arbitrarily close to zero while this never happens under incomplete markets. Intuitively, under complete markets agents pledged their future income, while collateral constraints put limits on such transactions. While allocations in which some agents experience very low levels of consumption may not be attractive according to some social welfare criteria, the equilibrium under complete markets is Pareto optimal under the subjective expectations of the agents. This result also implies that there is the possibility for Pareto improving regulations. However, given that this result is about unconstrained Pareto-efficiency, Pareto improving regulations might involve altering the incomplete markets structure.<sup>2</sup>

The above mentioned results are derived under the presumption that incomplete markets equilibria exist. However, establishing existence of incomplete markets equilibria is generally a challenging task. The third set of results establishes the existence of incomplete markets equilibria with a stationary structure. In their seminal paper, Geanakoplos and Zame (2002) shows that, with collateral constraints, the standard existence proof a la Debreu (1959) applies. Kubler and Schmedders (2003) extends the existence proof to infinite horizon economies. I use the insights from these works to show the existence of incomplete

---

<sup>2</sup>For a two-period version of my model, the concept of constrained Pareto-inefficiency due to Geanakoplos and Polemarchakis (1986) can be checked. In some cases, the economy can be constrained inefficient in this sense, due to pecuniary externalities.

markets equilibria in finite and infinite horizon economies with production and capital accumulation. Following Kubler and Schmedders (2003), I look for *Markov equilibria*, i.e., in which equilibrium prices and quantities depend only on the distribution of *normalized financial wealth* and the total quantities of assets with elastic supply. I show the existence of the equilibria under standard assumptions. I also develop an algorithm, based on the algorithm in Kubler and Schmedders (2003), to compute these equilibria. The same algorithm can be used to compute the complete markets equilibrium benchmark. One direct corollary of the existence theorem is that the recursive equilibrium in Krusell and Smith (1998) exists.

The fourth set of results attempts to answer some normative questions in this framework. Simple and extreme forms of financial regulations such as shutting down financial markets are not beneficial. Using the algorithm described above, I provide numerical results illustrating that these regulations fail to reduce asset price volatility and moreover they may also reduce the welfare of all agents because of the restrictions they impose on mutually beneficial trades. In particular, the intuition for the greater volatility under such regulations is that, when the collateral constraints are binding, regulations restrict the demand for assets. Therefore asset prices are lower than they are in unregulated economies. Agents, however, will eventually save their way out of the constrained regime, at which point, asset prices will become comparable to the unregulated levels. Movements between constrained and unconstrained regimes create high asset price volatility. These results suggest that Pareto-improving or volatility reducing regulations must be sophisticated, for example, incorporating state-dependent regulations.

This paper is related to the growing literature studying collateral constraints, started with a series of papers by John Geanakoplos. The dynamic analysis of incomplete markets is closely related to Kubler and Schmedders (2003). They pioneer the introduction of financial markets with collateral constraints into a dynamic general equilibrium model with aggregate shocks and heterogeneous agents. There are two main technical contributions of this paper relative to Kubler and Schmedders (2003). The first is to introduce heterogeneous beliefs using Radner (1972) rational expectations equilibrium concept: even though agents assign different probabilities to the aggregate shocks, they agree on the equilibrium outcomes, including prices and quantities, once a shock is realized. This rational expectations concept differs from the standard rational expectation concept, such as the one used in Lucas and Prescott (1971), in which subjective probabilities should coincide with the true conditional probabilities given all the available information. The second is to introduce capital accumulation and production in a tractable way. Capital accumulation or real investment is modelled through intermediate asset producers with convex adjustment costs that convert old units of assets into new units of assets using final good.<sup>3</sup> The analysis of efficiency is related to Kilenthong (2009) and Kilenthong and Townsend (2009). They examine a similar but static environment.

My paper is also related to the literature on the effect of heterogeneous beliefs on asset prices studied in Xiong and Yan (2009) and Cogley and Sargent (2008). These authors, however, consider only complete markets. The survival of irrational traders is studied Long, Shleifer, Summers, and Waldmann (1990) and Long, Shleifer, Summers, and Waldmann (1991) but they do not have a fully dynamic framework to study the long run survival of

---

<sup>3</sup>Lorenzoni and Walentin (2009) models capital accumulation with adjustment cost using used capital markets. Through asset producers, I assume markets for both used and new capital.

the traders. Simsek (2009b) also studies the effects of belief heterogeneity on asset prices. He assumes exogenous wealth distributions to investigate the question which forms of heterogeneous beliefs affect asset prices. In contrast, I study the effects of the endogenous wealth distribution on asset prices as well as asset price volatility. Simsek (2009a) focuses on consumption volatility. He shows that as markets become more complete, consumption becomes more volatile as agents can speculate more. My first set of results suggests that this comparative statics only holds in the short run. In the long run, the reverse statement holds due to market selection.

Related to the survival of agents with incorrect beliefs Coury and Sciuabba (2005) and Beker and Chattopadhyay (2009) suggest a mechanism for agents' survival based on explicit debt constraints as in Magill and Quinzii (1994). These authors do not consider the effects of the agents' survival on asset prices. My framework is tractable enough for a simultaneous analysis of survival and its effects on asset prices and investment. Beker and Espino (2010) has a similar survival mechanism to mine based on the limited commitment framework in Alvarez and Jermann (2000). However, my approach to asset pricing is different because asset prices are computed explicitly as function of wealth distribution. Moreover, my approach also allows a comprehensive study of asset-specific leverage. Kogan, Ross, Wang, and Westerfield (2006) explore yet another survival mechanism but use complete markets instead.

The model in this paper is a generalization of Krusell and Smith (1998) with financial markets and adjustment costs. In particular, the existence theorem 2 shows that a recursive equilibrium in Krusell and Smith (1998) exists. Krusell and Smith (1998) derives numerically such an equilibrium, but they do not formally show its existence. My paper is also related to Kiyotaki and Moore (1997), although I provide a microfoundation for the financial constraint (3) in their paper using the endogeneity of the set of actively traded financial assets.

The rest of the paper proceeds as follow. In section 2, I present the model in its most general form and preliminary analysis of survival, asset price volatility and investment volatility under the complete markets benchmark as well as under incomplete markets. In section 3, I define and show the existence of incomplete markets equilibria under the form of Markov equilibria. In this section, I also prove important properties of Markov equilibria in this model. In section 4, I derive a general numerical algorithm to compute Markov and competitive equilibria. Section 5 focuses on assets in fixed supply with an example of only one asset to illustrate the ideas in sections 2 and 3. Section 6 concludes with potential applications of the framework in this paper. Lengthy proofs and constructions are in the Appendix.

## 2 General model

In this general model there are heterogeneous agents who differ in their beliefs about the future streams of dividend or about future productivities. There are also different types of assets (for examples trees, land, housing and machines) that differ in their adjustment costs, associated production technologies and collateral value.

## 2.1 The environment

There are  $H$  types of consumers,  $h \in \mathcal{H} = \{1, 2, \dots, H\}$  in the economy (there is a continuum of measure 1 of identical consumers in each type) with potentially different instantaneous preferences  $U_h(c)$ , discount rates  $\beta_h$ , endowments of good  $e_h$  and of labor  $L_h$ . They might also differ in their belief of the evolution of the aggregate productivities and of the aggregate dividend streams. In each period, there are  $S$  states of the world:  $s \in \mathcal{S} = \{1, 2, \dots, S\}$ . Histories are denoted by

$$s^t = (s_0, s_1, \dots, s_t),$$

the series of realizations of shocks up to time  $t$ . Notice that the space  $S$  can be chosen large enough to encompass both aggregate shocks, such as shocks to the productivity of aggregate production functions, to aggregate dividends, and idiosyncratic shocks, such as labor income shocks.<sup>4</sup>

There is only one final good in this economy. It can be consumed by consumer and can be used for the production of new units of assets. It is produced by final good producers specified below.

**Real Assets:** There are  $A$  types  $a \in \mathcal{A} = \{1, 2, \dots, A\}$  of physical assets.

*Adjustment cost:* There are two types of assets, one with elastic supply,  $a \in \mathcal{A}_0$  and the other ones with fixed supply,  $a \in \mathcal{A}_1$ , associated with adjustment cost functions. Let  $A_0, A_1$  respectively denote the numbers of assets with elastic and fixed supply.

We can think of assets with fixed supply,  $a \in \mathcal{A}_1$ , as having infinite adjustment costs, however for the rigorousness of the model, I treat them differently from the assets with elastic supply.

For each asset with elastic supply,  $a \in \mathcal{A}_0$ , in each period,  $k_a^n$  new units of asset  $a$  can be produced using  $k_a^o$  old units of asset  $a$  and  $\Psi_a(k_a^n, k_a^o)$  units of the final good. The  $k_a^n$  new units are used for production in the next period. Let  $q_{a,t}$  denote the ex-dividend price of each old unit of asset  $a$ , and  $q_{a,t}^*$  denote the price of each new unit of asset  $a$ . Notice that  $\Psi_a(k_a^n, k_a^o)$  is the final good investment associated to asset  $a$ . One example typically used in macroeconomics, representing perfectly flexible investment, is

$$\Psi_a(k_a^n, k_a^o) = k_a^n - (1 - \delta_a) k_a^o. \quad (1)$$

Another example with nonlinearity is the one used in Lorenzoni and Walentin (2009)

$$\Psi_a(k_a^n, k_a^o) = k_a^n - (1 - \delta_a) k_a^o + \frac{\xi_a}{2} \frac{(k_a^n - k_a^o)^2}{k_a^o},$$

in which  $0 < \xi_a < \min\{2(1 - \delta_a), 1\}$ .

We can also rewrite the adjustment cost under a more familiar form

$$k_a^n = (1 - \delta_a) k_a^o + k_a^o \Phi\left(\frac{i_a}{k_a^o}\right), \quad (2)$$

in which  $i_a$  is real investment in terms of final good.  $\Phi(\cdot)$  is strictly increasing and weakly concave. Perfectly investment case(1) corresponds to  $\Phi(x) = x$ .

---

<sup>4</sup>See Krusell and Smith (1998) for a similar framework with incomplete market with both aggregate shocks and idiosyncratic shocks.



I make the following standard assumption on the adjustment cost function. This assumption ensures that the profit maximization of each asset producer yields upper-hemicontinuous and convex solutions.

**Assumption 1** *The adjustment cost function  $\Psi_a$  is homogeneous of degree 1 and convex in  $(k_a^n, -k_a^o)$ . Moreover,  $\Psi_a$  is strictly increasing in  $k_a^n$  and strictly decreasing in  $k_a^o$ .*

*Production:* Assets with fixed supply,  $a \in \mathcal{A}_1$  generate a state-dependent stream of dividend  $d_a(s)$ . Asset with elastic supply can be used in production function with state-dependent production functions  $F_a(K_a, L_a, s)$ , in which  $K_a$  are units of assets of type  $a$  and  $L_a$  is labor of the type associated to the asset.

Similarly to the adjustment cost, I make the following standard assumption to ensure that the profit maximization of each final good producer yields upper-hemicontinuous and convex solutions.

**Assumption 2** *The production function  $F_a(K_a, L_a, s)$  is homogeneous of degree 1 and concave in  $(K_a, L_a)$  and strictly increasing in both parameters.*

One example is the standard Cobb-Douglas production function with state-dependent productivity used in the RBC literature

$$F_a(K_a, L_a, s) = A(s) K_a^{\alpha_a} L_a^{1-\alpha_a}.$$

**Financial Assets:** In each history  $s^t$ , there are also financial assets,

$$j \in \mathcal{J}_t = \{1, 2, \dots, J_t\}.$$

The set of financial assets may depend on event nodes. Asset  $j$  traded at that node promises pay-off  $b_j(s^{t+1}) = b_j(s_{t+1}) > 0$  in term of final good at the successor nodes  $s^{t+1} = (s^t, s_{t+1})$ . Agents can only sell the financial asset  $j$  if they hold shares of real assets as collateral. We associate  $j$  with an  $A$ -dimensional vector  $k^j \geq 0$  of collateral requirements. If an agent sells one unit of security  $j$ , she is required to hold  $k_a^j$  units of asset  $a = 1, 2, \dots, A$  as collateral. If an asset  $a$  can be used as collateral for different financial securities, the agent is required to invest  $k_a^j$  in each asset  $a$  for each  $j = 1, \dots, J$ .

Since there are no penalties for default, a seller of the financial asset defaults at a node  $s^{t+1}$  whenever the total value of collateral assets falls below the promise at that state. By individual rationality, the actual pay-off of security  $j$  at node  $s^t$  is therefore always given by

$$f_{j,t+1}(s^{t+1}) = \min \left\{ b_j(s_{t+1}), \sum_{a=1}^A k_a^j (q_a(s^{t+1}) + d_a(s^{t+1})) \right\} \quad (3)$$

Let  $p_{j,t}(s^t)$  denote price of security  $j$  at node  $s^t$ .

I allow  $k^j$  to depend on the current aggregate state as well as current and future prices. But I impose a lower bound on  $k^j$  to ensure that the supply of the financial assets are endogenously bounded in equilibrium. I also impose an upper bound on  $k^j$  to obtain an upper bound on prices of these financial assets in equilibrium. The lower and upper bounds can be chosen such that they are not binding in equilibrium.

**Assumption 3** *There exist  $\bar{k}$  and  $\underline{k}$  strictly positive such that*

$$\underline{k} < k_a^j(s_t, d_t, q_t, q_{t+1}) < \bar{k}.$$

for all  $a, j, s_t, d_t, q_t, q_{t+1}$ .

By allowing  $k_a^j$  to depend on current and future prices, I want to capture the case

$$k_{a,t}^j = \max_{s^{t+1}|s^t} \left\{ \frac{b_j(s_{t+1})}{q_a(s^{t+1}) + d_a(s^{t+1})} \right\}. \quad (4)$$

$k_{a,t}^j$  is the minimum collateral level that ensures no default. Therefore

$$f_{j,t+1}(s^{t+1}) = b_j(s_{t+1}).$$

This constraint captures the situation in Kiyotaki and Moore (1997) in which agents can borrow only up to the minimum across future states of the future value of their land<sup>5</sup>. With  $S = 2$ , and state non-contingent debts, i.e.,  $b_j(s_{t+1}) = b_j$ , Geanakoplos (2009) argues that even if we allow for a wide range of collateral level, that is the unique collateral level that prevails in equilibrium. This statement for two future states still holds in this context of infinitely-lived agents as proved later in subsection 5. However, this might not be true if we have more than 2 future states.

Beside the group of consumers, there are two other groups of agents in this economy: the asset producers and the final good producers. These producers live only for one period, therefore they do not have to make inter-temporal decisions.

**Asset Producers:** In each state, there are  $A_0$  representative asset producers. Asset producer  $a \in \mathcal{A}_0$  produces  $K_{a,t}^n$  unit of new asset from  $K_{a,t-1}^o$  old units of old assets and  $\Psi_a(K_{a,t}^n, K_{a,t-1}^o)$  units of final good. The producers take prices  $q_{a,t}^*$  and  $q_{a,t}$  as given to maximize their profit

$$\pi_t^a = \max_{\substack{K_{a,t}^n, K_{a,t-1}^o \geq 0 \\ \psi_{a,t} \geq \Psi_a(K_{a,t}^n, K_{a,t-1}^o)}} q_{a,t}^* K_{a,t}^n - \psi_{a,t} - q_{a,t} K_{a,t-1}^o. \quad (5)$$

**Final Good Producers:** In each state there is also  $A_0$  representative final good producers. Producer  $a \in \mathcal{A}_0$  produces  $F_a(K_a, L_a, s)$  units of final good from  $K_a$  units of asset  $a$  and  $L_a$  units of labor associated to the asset<sup>6</sup>. The producers take rental prices  $d_{a,t}$  and wages  $w_{a,t}$  as given to maximize their profit

$$\pi_t^{f,a} = \max_{\substack{K_{a,t}^f, L_{a,t}, y_{a,t} \geq 0 \\ y_{a,t} \leq F_a(K_{a,t}^f, L_{a,t}, s_t)}} y_{a,t} - d_{a,t} K_{a,t}^f - w_t L_{a,t} \quad (6)$$

The consumers are the main actors in this economy, they make consumption saving and investment decisions based on their own assessment of the future prospects of the economy.

<sup>5</sup>Of course, the collateral level in (4) does not satisfy Assumption 3. However, we can use an alternative collateral level  $\bar{k}_a^j = \max(k_a^j, \epsilon)$  and show that in equilibrium  $\bar{k}_a^j = k_a^j$  if we choose  $\epsilon$  small enough.

<sup>6</sup>In an alternative model, assets use the same type of labor. That model is similar to the one presented here.

**Consumers:** In each state  $s^t$ , each consumer is endowed with  $e_t^h = e^h(s_t)$  units of final good. I suppose there is a strictly positive lower bound on these endowments. This lower bound guarantees a lower bound on consumption, if a consumer decides to default on all her debt and withdraw from the financial markets.

**Assumption 4** *There exists an  $\underline{e} > 0$  such that  $e_h(s) > \underline{e}$  for all  $h$  and  $s$ .*

For example, commercial banks receive deposits from their retail branches while these banks also have trading desks that trade independently in the financial markets.

She is also endowed with a vector of labor

$$L_h = (L_{h,a}(s_t))_{a \in \mathcal{A}_0},$$

$L_{h,a}$  corresponds to labor associated with asset  $a$ .

The consumer maximizes her intertemporal expected utility with the per period utility function  $U_h(\cdot) : \mathbf{R}^+ \rightarrow \mathbf{R}$  satisfies

**Assumption 5**  *$U_h$  is concave and strictly increasing.*

Notice that I do not require  $U_h$  to be strictly concave. This assumption captures linear utility functions in Geanakoplos (2009) and Harrison and Kreps (1978).

Consumer  $h$  takes sequences of prices as given and solves<sup>7</sup>

$$\max E_0^h \left[ \sum_{t=0}^{\infty} \beta^t U_h(c_t^h) \right]$$

and in each history  $s^t$ , she is subject to the budget constraint

$$\begin{aligned} & c_t^h + \sum_{a \in \mathcal{A}_1} q_{a,t} k_{a,t}^h + \sum_{a \in \mathcal{A}_0} q_{a,t}^* k_{a,t}^h + \sum_{j=1}^J p_{j,t} \phi_{j,t}^h \\ & \leq e_t^h + \sum_{a \in \mathcal{A}_0} w_{a,t} l_{a,t}^h + \sum_{j=1}^J f_{j,t} \phi_{j,t-1}^h + \\ & + \sum_{a \in \mathcal{A}_0} (q_{a,t} + d_{a,t}) k_{a,t-1}^h + \sum_{a \in \mathcal{A}_0} \Pi_a^h + \sum_{a \in \mathcal{A}_0} \Pi_a^{f,h} \\ & + \sum_{a \in \mathcal{A}_1} (q_{a,t} + d_{a,t}) k_{a,t-1}^h \end{aligned} \tag{7}$$

the collateral constraints

$$k_{a,t}^h + \sum_{j: \phi_{j,t} < 0} \phi_{j,t}^h k_{a,t}^j \geq 0 \tag{8}$$

---

<sup>7</sup>We can also introduce the disutility of labor in order to study employment in this environment. The existence of equilibria for finite horizon allows for labor choice decision.

One implicit condition from the assumption on utility functions is that consumptions are positive, i.e.,  $c_t^h \geq 0$ . In the constraint (8), if the consumer does not use asset  $a$  as collateral to sell any financial security, then the constraint becomes the no-short sale constraint

$$k_{a,t}^h \geq 0. \quad (9)$$

In the budget constraint (7),  $e_t^h$  is her endowment that can depend on the aggregate state  $s_t$ . Entering period  $t$ , the agent holds  $k_{a,t-1}^h$  old units of real asset  $a$  and  $\phi_{j,t-1}^h$  units of financial asset  $j$ . She can trade old units of real asset  $a$  at price  $q_{a,t}$ , buy new units of asset  $k_{a,t}^h$  for time  $t+1$  at price  $q_{a,t}^*$ . She can also buy and sell financial securities  $\phi_{j,t}^h$  at price  $p_{j,t}$ . If she sell financial securities she is subject to collateral requirement (8). Finally, she works at the wage  $w_{a,t}$  in each production sector  $a$ . She also receives her shares of profit from the asset producer and final good producer at time  $t$ ,  $\Pi_a^h$  and  $\Pi_a^{f,h}$ . However, given the homogeneity of the production functions, these profits should be zero in equilibrium.

Within a period, timing of decisions and actions taken by the agents are summarized in the following figure:

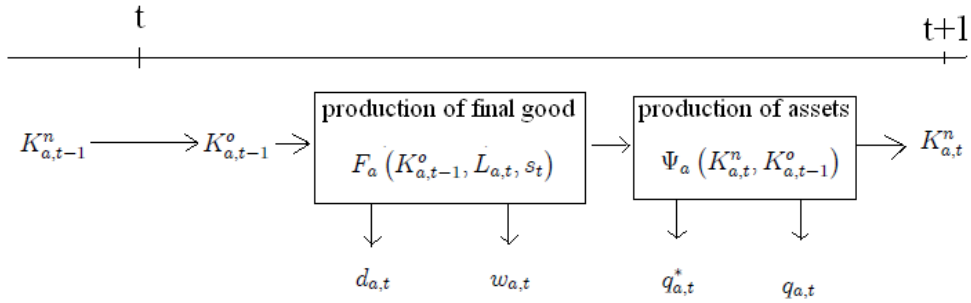

A number of features is worth noting in this setup: The demand of the consumers for new assets is similar to Tobin's Q theory of investment. They weigh the perceived marginal benefit of one additional unit of an asset  $a$ : future rental price,  $d_{a,t+1}$ , and future resale value  $q_{a,t+1}$ , against the marginal cost of buying one new unit of that asset at price  $q_{a,t}^*$ . The total demand for new units of asset  $a$  from the consumers is decreasing in price  $q_{a,t}^*$  and the supply of the asset from the asset producers is increasing in  $q_{a,t}^*$ . In equilibrium both  $q_{a,t}^*$  and  $K_{a,t}^n$  are determined simultaneously. For instance, if the consumers expect low future resale price of an asset, they will demand less for new units of the asset. This low demand leads to low current price and low investment in the asset.

In this environment, I define an equilibrium as follows

**Definition 1** *An incomplete markets equilibrium for an economy with initial asset holdings*

$$\{k_{a,0}^h\}_{h \in \{1,2,\dots,H\}}$$

and initial shock  $s_0$  is a collection

$$\begin{aligned} & \{c_t^h(s^t), l_{a,t}^h(s^t), k_{a,t}^h(s^t), \phi_{j,t}^h(s^t)\}_{h \in \{1, 2, \dots, H\}} \\ & \{K_{a,t}^n(s^t), K_{a,t}^o(s^t), \psi_{a,t}(s^t)\}_{a \in \mathcal{A}_0} \\ & \{K_{a,t}^f(s^t), L_{a,t}(s^t), y_{a,t}(s^t)\}_{a \in \mathcal{A}_0} \\ & \{q_{a,t}^*(s^t), q_{a,t}(s^t), d_{a,t}(s^t), w_{a,t}(s^t)\}_{a \in \mathcal{A}_0} \\ & \{q_{a,t}(s^t)\}_{a \in \mathcal{A}_1}, \{p_{j,t}(s^t)\}_{j \in J_t(s^t)} \end{aligned}$$

satisfying the following conditions

i) Asset markets, labor market for each asset with elastic supply  $a \in \mathcal{A}_0$  in each period clears: Demand by the consumers for new units of assets  $a$  equals supply of new units by the asset  $a$  producer:

$$\sum_{h=1}^H k_{a,t}^h(s^t) = K_{a,t}^n(s^t),$$

Demand by the asset  $a$  producer for old units of assets  $a$  equal supply of old units by the consumers:

$$K_{a,t}^o(s^t) = \sum_{h=1}^H k_{a,t-1}^h(s^t),$$

Demand by the asset  $a$  final good producer for old units of assets  $a$  equal supply of old units by the consumers:

$$K_{a,t}^f(s^t) = \sum_{h=1}^H k_{a,t-1}^h(s^t).$$

Labor demand by the asset  $a$  final good producer equal total labor supply by the consumers:

$$L_{a,t} = \sum_{h=1}^H L_{a,t}^h(s^t).$$

Market for each financial asset  $j$  clears:

$$\sum_{h=1}^H \phi_{j,t}^h(s^t) = 0.$$

ii) For each consumer  $h$ ,  $\{c_t^h(s^t), k_{a,t}^h(s^t), \phi_{j,t}^h(s^t)\}$  solves the individual maximization problem subject to the budget constraint, (7), and the collateral constraint, (8). Asset producers and final good producers maximize their profit as in (5) and (6).

Notice that by setting the set of financial securities  $J_t$  is empty in each event node, we obtain a model with no financial markets, agents are only allowed to trade in real assets, but they cannot short-sell these assets. There are two important special cases of such a model. The first one is the case in which there are only asset in fixed-supply, i.e.,  $\mathcal{A}_0$  is

empty. This case corresponds to Lucas (1978)'s model with several trees and heterogeneous agents. The second one is the case in which there is only one asset with perfect elastic supply, i.e., adjustment cost described in (1). This case corresponds to Krusell and Smith (1998)'s model if we expand the set of aggregate shocks to incorporate idiosyncratic shocks of each individual and allow for a large number of agents. Therefore we can apply the existence proof in section 3 to show the existence of the recursive equilibrium in their original paper.

As benchmark I also study equilibrium with complete financial markets. Consumers and borrow and lend freely by buying and selling Arrow-Debreu state contingent securities, only subject to the no-Ponzi condition. In each node  $s^t$ , there are  $S$  financial securities. Financial security  $s$  deliver one unit of final good if state  $s$  happens at time  $t + 1$  and zero otherwise. Let  $p_{s,t}$  denote time  $t$  price and let  $\phi_{s,t}^h(s^t)$  denote consumer  $h$ 's holding of this security. The budget constraint (7) of consumer  $h$  becomes

$$\begin{aligned}
& c_t^h + \sum_{a \in \mathcal{A}_1} q_{a,t} k_{a,t}^h + \sum_{a \in \mathcal{A}_0} q_{a,t}^* k_{a,t}^h + \sum_{s \in \mathcal{S}} p_{s,t} \phi_{s,t}^h \\
& \leq e_t^h + \sum_{a \in \mathcal{A}_0} w_{a,t} l_{a,t}^h + \phi_{s^t, t-1}^h + \\
& \quad + \sum_{a \in \mathcal{A}_0} (q_{a,t} + d_{a,t}) k_{a,t-1}^h + \sum_{a \in \mathcal{A}_0} \Pi_a^h + \sum_{a \in \mathcal{A}_0} \Pi_a^{f,h} \\
& \quad + \sum_{a \in \mathcal{A}_1} (q_{a,t} + d_{a,t}) k_{a,t-1}^h
\end{aligned} \tag{10}$$

**Definition 2** A *complete markets equilibrium* is defined similarly to *incomplete markets equilibrium* except that each consumer solves her individual maximization problem subject to the budget constraint (10) and the no-Ponzi condition, instead of the collateral constraint (8).

In the next subsection, I establish some properties of incomplete markets equilibrium. I compare each of these properties to the one of complete markets equilibrium.

## 2.2 General properties of incomplete and complete markets equilibria

First, I restrict myself to studying equilibria in which the total quantities of assets with elastic supply are bounded, i.e., for each  $a \in \mathcal{A}_0$ , there exists a upper bound  $\bar{K}_a$  such that  $K_{a,t}(s^t) \leq \bar{K}_a$  for all  $t, s^t$ . Given this restriction we can show easily that total supply of final good in each period is bounded by a constant  $\bar{e}$ . Indeed in each period, total supply of final good is

$$\begin{aligned}
& \sum_{h \in \mathcal{H}} e^h + \sum_{a \in \mathcal{A}_1} d_a K_a + \sum_{a \in \mathcal{A}_0} F \left( K_a^o, \sum_h L_h^a \right) - \sum_{a \in \mathcal{A}_0} \Psi_a(K_a^n, K_a^o) \\
& \leq \sum_{h \in \mathcal{H}} e^h + \sum_{a \in \mathcal{A}_1} d_a K_a + \sum_{a \in \mathcal{A}_0} F \left( \bar{K}_a, \sum_h L_h^a \right) - \sum_{a \in \mathcal{A}_0} \Psi_a(0, \bar{K}_a) < \bar{e}.
\end{aligned} \tag{11}$$

The first term is the total final good endowment of each individual. The second is total dividends from fixed-supply assets. The third and fourth terms are the maximum amount of final good that can be produced using elastic supply assets. Given that  $\mathcal{S}$  is finite; we can choose an upper bound  $\bar{e}$  of total final good over aggregate states  $s \in \mathcal{S}$ . In incomplete or complete markets equilibria, the market clearing condition for final good implies that total consumption is bounded from above by  $\bar{e}$ . Given that consumption of every agent is always positive, consumption of each agent is bounded from above by  $\bar{e}$ , i.e.,

$$c_{h,t}(s^t) \leq \bar{e} \quad \forall t, s^t. \quad (12)$$

Under the boundedness of total quantities of assets, we can show that in any incomplete markets equilibrium, consumption of consumers is bounded from below by a strictly positive constant  $\underline{c}$ . Two assumptions are important for this result. First, no-default penalty allow consumers, at any moment in time, to walk away from their past debts and only lose their collateral assets. After defaulting, they can always keep their non-financial wealth (inequality (14) below). Second, increasingly large speculation by postponing current consumption is not an equilibrium strategy, because in equilibrium consumption is bounded by  $\bar{e}$  (inequality (15) below). These assumptions prevent agents from constantly postponing their consumption to buy assets. Formally, we have the following proposition

**Theorem 1** *Suppose that in a incomplete markets equilibrium, there is an upper bound on total quantities of assets with elastic supply. Moreover, there exists  $\underline{c}$  such that*

$$U_h(\underline{c}) < \frac{1}{1-\beta} U_h(\underline{e}) - \frac{\beta}{1-\beta} U_h(\bar{e}), \quad (13)$$

where  $\bar{e}$  is defined in (11). Then in a incomplete markets equilibrium, consumption of each consumer in each history node always exceeds  $\underline{c}$ .

**Proof.** As in (12) we can find an upper bound for consumption of each consumer. In each period one of the feasible strategies of consumer  $h$  is to default on all her past debts and consume her endowment from the current period on, therefore

$$U_h(c_{h,t}) + E_t^h \left[ \sum_{r=1}^{\infty} \beta^r U_h(c_{h,t+r}) \right] \geq \frac{1}{1-\beta} U_h(\underline{e}). \quad (14)$$

Notice that in equilibrium,  $\sum_h c_{h,t+r} \leq \bar{e}$  therefore  $c_{h,t+r} \leq \bar{e}$ . So

$$U_h(c_h) + \frac{\beta}{1-\beta} U_h(\bar{e}) \geq \frac{1}{1-\beta} U_h(\underline{e}) \quad (15)$$

This implies

$$U_h(c_h) \geq \frac{1}{1-\beta} U_h(\underline{e}) - \frac{\beta}{1-\beta} U_h(\bar{e}) > U_h(\underline{c})$$

■

Two remarks can be made here. First, condition (13) is automatically satisfied if

$$\lim_{c \rightarrow 0} U_h(c) = -\infty,$$

for example, with log utility or CRRA utility with CRRA constant exceeds 1. Second, the lower bound of consumption,  $\underline{c}$ , is decreasing in  $\bar{e}$ . Therefore, the more the total available final good, the more profitable speculative activities are and the more incentives consumers have to defer current consumption to engage into these activities.

One immediate corollary of this proposition is that, every consumer survives in equilibrium. Therefore, incomplete markets equilibrium differs from complete markets equilibrium when consumers differ in their beliefs. The proposition below shows that in a complete markets equilibrium, with strict difference in beliefs, consumption of certain consumer will come arbitrarily close to 0 at some event node. The intuition for this result is that, if an agent believes that the likelihood of a state is much smaller than what other agents believe, the agent will want to exchange his consumption in that state for consumption in other states. Complete markets allow her to do so but, in incomplete markets equilibrium, collateral constraint limits the amount of consumption that she can sell in each state.

**Proposition 1** *Suppose there is an upper bound on total quantities of assets with elastic supply and consumers have strictly heterogeneous beliefs. Moreover, the utility functions satisfy the Inada-condition*

$$\lim_{c \rightarrow 0} U'_h(c) = +\infty.$$

*Then, in a competitive equilibrium with complete markets, consumption of some agent comes arbitrarily close to zero at some state of the world. Formally*

$$\inf_{h, s^t} c_h(s^t) = 0.$$

**Proof.** From the first-order condition

$$\left( \prod_{r=0}^{t-1} p_{s_{r+1}}(s^r) \right) U'_h(c_{h,0}) = P_h(s^t|s_0) U'_h(c_t(s^t))$$

Therefore for  $h, h'$

$$\frac{U'_h(c_h(s^t))}{U'_{h'}(c_{h'}(s^t))} = \frac{P_{h'}(s^t|s_0) U'_{h'}(c_{h'}(0))}{P_h(s^t|s_0) U'_h(c_h(s_0))} \quad (16)$$

From inequality (12), we have  $U'_{h'}(c_{h'}(s^t)) > U'_{h'}(\bar{e})$ , therefore

$$U'_h(c_h(s^t)) > \frac{P_{h'}(s^t|s_0) U'_{h'}(c_{h'}(0))}{P_h(s^t|s_0) U'_h(c_h(s_0))} U'_{h'}(\bar{e}).$$

But given heterogeneity in belief, we can find  $s^t$  and  $h, h'$  such that  $\frac{P_{h'}(s^t|s_0)}{P_h(s^t|s_0)}$  gets arbitrarily large. So  $c_h(s^t)$  goes to zero as  $\frac{P_{h'}(s^t|s_0)}{P_h(s^t|s_0)}$  goes to infinity. ■

Blume and Easley (2006) and Sandroni (2000) show an even stronger result: Under some agent's belief, with probability one, consumption of agents whose beliefs strictly differ from hers goes to zero at infinity. Their proofs use difficult results from probability theory, however the first-order conditions 16 play the main role in the proofs.

The survival mechanism in Theorem 1 is similar to the one in Beker and Espino (2010) which is again based on Alvarez and Jermann (2000). The idea is that agents have limited



ability to pledge their future income, for example labor income. As the result they can always default and keep their future income. This limited commitment is even stronger in my setting than in Alvarez and Jermann (2000) and Beker and Espino (2010) because after defaulting agents can always come back and trade in the financial markets by buying new physical assets. This survival mechanism also shows that agents can disappear in Blume and Easley (2006) and Sandroni (2000) because they can perfectly commit to pay their creditor using their future income. They can do so using short-term debts and keep rolling over their debts while using their present income to pay the interests.<sup>8</sup>

Due to different conclusions about agents' survival, the following corollary asserts that complete and incomplete markets allocations strictly differ when some agents strictly differ in their beliefs.

**Corollary 1** *Suppose that conditions in Theorem 1 and Proposition 1 are satisfied and some agents strictly differ in their beliefs. Then, an incomplete markets equilibrium never yields an allocation that can be supported by a complete markets equilibrium. By the Second Welfare Theorem, incomplete markets equilibrium allocations are Pareto-inefficient.*

**Proof.** In a incomplete markets equilibrium, consumptions are bounded away from 0, but in a complete markets equilibrium, consumptions of some agents will approach 0. Therefore, the two sets of allocations never intersect. ■

Using this corollary, we can formalize and show the shortages of collateral assets.

**Proposition 2 (Collateral Shortages)** *Suppose that  $J_t$  includes complete set of state-contingent Arrow-Debreu securities. Then, for any given time  $t$ , the collateral constraints must be binding for some agent after time  $t$ , despite the fact that collateral assets can be produced.*<sup>9</sup>

**Proof.** We prove this corollary by contradiction. Suppose none of the collateral constraints are binding after certain date. Then we can take the first-order condition with respect to the state-contingent securities. This leads to consumption of some agent approaches zero at infinity, as shown in the proof of Proposition 1. This contradicts the conclusion of Theorem 1. ■

Araujo, Kubler, and Schommer (2009) argue that when there are enough collateral we might reach the Pareto optimal allocation. However, in the complete markets case, there will never be enough collateral. Moreover, this conclusion holds even if we allow for elastic

---

<sup>8</sup>The following story of the founder of Long Term Capital Management show that traders in the financial markets often have limited commitment: John Meriwether worked as a bond trader at Salomon Brothers. At Salomon, Meriwether rose to become the head of the domestic fixed income arbitrage group in the early 1980s and vice-chairman of the company in 1988. In 1991, after Salomon was caught in a Treasury securities trading scandal Meriwether decided to leave the company. Meriwether founded the Long-Term Capital Management hedge fund in Greenwich, Connecticut in 1994. Long-Term Capital Management spectacularly collapsed in 1998. A year after LTCM's collapse, in 1999, Meriwether founded JWM Partners LLC. The Greenwich, Connecticut hedge fund opened with \$250 million under management in 1999 and by 2007 had approximately \$3 billion. The Financial crisis of 2007-2009 badly battered Meriwether's firm. From September 2007 to February 2009, his main fund lost 44 percent. On July 8, 2009, Meriwether closed the fund.

<sup>9</sup>It can also be shown that, at any moment of time, for *every* agent, the collateral constraint must be binding some time in future.

supply of collateralizable assets. Collateral shortages in this context mean that at some point in time some agent only hold the assets for collateral purposes but not for investment and saving purposes.

We also emphasize here the difference between belief heterogeneity and other forms of heterogeneity such as heterogeneity in endowments or in risk-aversion. The following proposition, in the same form Theorem 5 in Geanakoplos and Zame (2007), shows that if consumers share the same belief and discount rate, there exist endowment profiles with which, collateral equilibria attain the first-best allocations.

**Proposition 3** *If consumers share the same belief and discount factor, there is an open set of endowment profiles with the properties that the competitive equilibrium can be supported by a financial market equilibrium.*

**Proof.** We start with an allocation such that there is no trade in the complete markets equilibrium, then as we move to a neighborhood of that allocation, all trade can be collateralized.

■

Lastly, we go back to the complete markets benchmark to study the behavior of asset price volatility. We will compare this volatility with the one in the collateralized economy and show that, in general, in the long run, asset price more volatile in a incomplete markets equilibrium than it is in a complete markets equilibrium.

**Proposition 4** *Suppose that there are some agent with the correct belief and that there are no elastic supply assets. Then in the complete markets equilibrium, asset prices are independent of past realizations of the aggregate shocks in the long run.*

**Proof.** Blume and Easley (2006) shows that in the long run, only agents with correct belief survive. Therefore, in the long run, we fall back to the case with homogeneous belief. Given markets completeness, there exists a representative agent with instantaneous utility function  $U_{\text{Rep}}$ , and her marginal utility evaluated at the total endowment determines asset prices

$$\begin{aligned} q_a(s^t) U'_{\text{Rep}}(e(s_t)) &= \beta E_t^{\text{Rep}} \left\{ (q_a(s^{t+1}) + d_a(s_{t+1})) U'_{\text{Rep}}(e(s_{t+1})) \right\} \\ &= E_t^{\text{Rep}} \left\{ \sum_{r=1}^{\infty} d_a(s_{t+r}) \beta^r U'_{\text{Rep}}(e(s_{t+r})) \right\} \end{aligned} \quad (17)$$

in which  $e(s)$  is the aggregate endowment in the aggregate state  $s$ . We can see easily from this expression that  $q_a(s^t)$  is history-independent. ■

When there are assets with elastic supply, this proposition should be modified as, controlling for total quantities of assets with elastic supply, asset prices are independent of past realizations of the aggregate shocks.

In contrast to complete markets equilibrium, in the next section we will show that, in incomplete markets equilibrium, asset prices can be history-dependent, as past realizations of aggregate shocks affect the wealth distribution, which in turns affects asset prices.

One issue might arise when one tries to interpret Proposition 4 is that, in some economy, there might not be any consumer whose belief coincides with the truth. For example, in Scheinkman and Xiong (2003), all agents can be wrong all the time, except they constantly

switch from over-optimistic to over-pessimistic. To avoid this issue, I use the language in Blume and Easley (2006) and Sandroni (2000). I reformulate the results above using the subjective belief of each consumer.

**Proposition 5** *Suppose that there are no assets with elastic supply, and condition (13) is satisfied. Then each agents believes that:*

- 1) *In complete markets equilibrium, only her and consumers sharing her belief survive in the long run. However, in incomplete markets equilibrium, everyone survives in the long run.*
- 2) *In complete markets equilibrium, asset prices are history-independent. However, in incomplete markets equilibrium, asset price can be history-dependent.*

The properties in this section are established under the presumption that incomplete markets equilibria exists. The next section is devoted to show the existence of these equilibria with a stationary structure. The next two sections follow closely the organization in Kubler and Schmedders (2003). The first shows the existence and the second presents an algorithm to compute the equilibria.

## 3 Markov Equilibrium

### 3.1 The state space

I define the financial wealth of each agent by

$$\omega_t^h = \frac{\sum_a (q_{a,t} + d_{a,t}) k_{a,t-1}^h + \sum_j \phi_{j,t}^h f_{j,t-1}}{\sum_a (q_{a,t} + d_{a,t}) K_{a,t-1}^o}.$$

Let  $\omega(s^t) = (\omega^1(s^t), \dots, \omega^H(s^t))$ . Then in equilibrium  $\omega(s^t)$  always lies in the (H-1)-dimensional simplex  $\Omega$ , i.e.,  $\omega^h \geq 0$  and  $\sum_{h=1}^H \omega^h = 1$ .  $\omega^h$ 's are positive because of the collateral constraint (8) that requires the value of each agents' asset holdings to exceed the liabilities from their past financial assets holdings. And the sum of  $\omega^h$  equals 1 because of the asset market clearing and financial market clearing conditions.

I will show that, under conditions detailed in Subsection 3.3 below, there exists a Markov equilibrium over a compact state space. I look for an equilibrium in which equilibrium prices and allocations depend only on the states  $(s_t, \omega_t, K_{t-1}^o) \in \mathcal{S} \times \Omega \times E$ , in which

$$E = \prod_{a \in \mathcal{A}_0} [0, \bar{K}_a].$$

$K_a^o \in [0, \bar{K}_a]$  are the total old units of assets with elastic supply at the beginning of a period.

Let the state space  $\mathcal{X}$  consist of all exogenous and endogenous variables that occur in the economy at some node  $\sigma$ , i.e.,  $\mathcal{X} = \mathcal{S} \times \mathcal{V}$ , where  $\mathcal{S}$  is the finite set of exogenous shocks and  $\mathcal{V}$  is the set of all possible endogenous variables.

In each node  $\sigma$ , an element  $v(\sigma) \in \mathcal{V}$  includes: the normalized wealth distribution  $(\omega_h(\sigma))_{h \in \mathcal{H}} \in \Omega$ , the total old units of assets with elastic supply  $(K_a^o)_{a \in \mathcal{A}_0} \in E$ ; together with consumers' decisions: consumption,  $H + HA_0$  current consumption and labor supply

$(c^h(\sigma), l_a^h(\sigma))_{h \in \mathcal{H}}$ ,  $HA + HJ$  real and financial asset holdings  $(k_a^h(\sigma), \phi_j^h(\sigma))_{h \in \mathcal{H}}$ . It also includes the  $4A_0$  current prices of new units of elastic supply assets, the prices of old units of these assets, the rental prices and wages associated with these assets

$$(q_a^*(\sigma), q_a(\sigma), w_a(\sigma), d_a(\sigma))_{a \in \mathcal{A}_0},$$

and  $A_1$  prices of assets with fixed supply  $(q_a(\sigma))_{a \in \mathcal{A}_1}$ . Finally it includes  $J$  prices of the financial assets  $(p_j(\sigma))_{j \in J}$ . Therefore  $\mathcal{V} = \Omega \times E \times \widehat{\mathcal{V}}$  with

$$\widehat{\mathcal{V}} = \mathbf{R}_+^H \times \mathbf{R}_+^{HA_0} \times \mathbf{R}_+^{AH} \times \mathbf{R}^{JH} \times \mathbf{R}_+^{4A_0} \times \mathbf{R}_+^{A_1} \times \mathbf{R}_+^J \quad (18)$$

the set of endogenous variables other than the wealth distribution and total old quantities of assets with elastic supply.

Finally, let  $\mathcal{X} \subset \mathcal{V}$  denote the set of vectors of all the endogenous variables that satisfy: 1) financial markets clears, 2) producers maximize their profit and 3) the budget constraints of consumers bind. Formally,

$$\sum_h \phi_j^h = 0$$

and

$$l_a^h = L_{h,a}.$$

In addition, for each  $a \in \mathcal{A}_0$ , given  $K_a^n = \sum_h k_a^h$  and  $L_a = \sum_h l_a^h$  we have

$$(K_a^n, K_a^o, \psi_a) \in \arg \max_{\substack{\widetilde{K}_a^n, \widetilde{K}_a^o \geq 0 \\ \widetilde{\psi}_a \geq \Psi_a(\widetilde{K}_a^n, \widetilde{K}_a^o)}} q_a^* \widetilde{K}_a^n - \widetilde{\psi}_a - q_a \widetilde{K}_a^o \quad (19)$$

and

$$(K_a^o, L_a, y_a) \in \arg \max_{\substack{\widetilde{K}_a^f, \widetilde{L}_a, \widetilde{y}_a \geq 0 \\ \widetilde{y}_a \leq F_a(\widetilde{K}_a^f, \widetilde{L}_a, s)}} \widetilde{y}_a - d_a \widetilde{K}_a^f - w_a \widetilde{y}_a \quad (20)$$

and consumers' budget constraints hold with equality<sup>1011</sup>

$$c^h = e^h + w \cdot l + \omega^h (q + d) \cdot K^o - q^* \cdot k - p \cdot \phi. \quad (21)$$

Notice that profit maximizations (19), (20) and binding budget constraints imply that good market clears

$$\sum_h c^h + \sum_{a \in \mathcal{A}_0} \Psi_a(K_a, K_a^o) = \sum_h e^h + \sum_{a \in \mathcal{A}_0} F_a(K_a^o, L_a, s).$$

<sup>10</sup>With some abuse of notation, we use  $q_a^* = q_a$  for  $a \in \mathcal{A}_1$ .

<sup>11</sup>Profit maximization conditions (19) and (20) imply zero profits from the producers, hence the absence of these profits in the consumers' budget constraint.

### 3.2 Markov Equilibrium Definition

In order to define a Markov equilibrium, I use the following definition of expectation correspondence. Given a state  $(s, v) \in \mathcal{X}$ , the 'expectation correspondence'

$$g : \mathcal{X} \rightrightarrows \mathcal{V}^{\mathcal{S}}$$

describes all next period states that are consistent with market clearing and agents' first-order conditions. A vector of endogenous variables

$$(v_1^+, v_2^+, \dots, v_S^+) \in g(x)$$

and  $(s, v_s^+) \in \mathcal{X}$  for each  $s \in \mathcal{S}$  if for all households  $h \in \mathcal{H}$  the following conditions holds

a) For all  $s \in \mathcal{S}$

$$\omega_s^{h+} = \frac{k^h \cdot (q_s^+ + d_s^+) + \sum_{j \in \mathcal{J}} \phi_j^h \min \{b_j(s), \sum_{a \in A} k_a^j (q^+ + d^+)\}}{\sum_a (q^+ + d^+) \cdot K^+}.$$

b) There exist multipliers  $\mu_a^h$  corresponding to collateral constraints such that

$$0 = \mu_a^h - q_a^* U_h'(c^h) + \beta_h E^h \{ (q_a^+ + d_a^+) U_h'(c^{h+}) \} \quad (22)$$

$$0 = \mu_a^h \left( k_a^h + \sum_{j \in \mathcal{J}: \phi_j^h < 0} k_a^j \phi_j^h \right)$$

$$0 \leq k_a^h + \sum_{j \in \mathcal{J}: \phi_j^h < 0} k_a^j \phi_j^h.$$

c) Define  $\phi_j^h(-) = \max(0, -\phi_j^h)$  and  $\phi_j^h(+) = \max(0, \phi_j^h)$ , there exist multipliers  $\eta_j^h(+)$  and  $\eta_j^h(-) \in \mathbf{R}^+$  such that

$$0 = \sum_{a \in A} \mu_a^h k_a^j - p_j U_h'(c^h) + \beta^h E^h \{ f_j^+ U_h'(c^{h+}) \} - \eta_j^h(-)$$

$$0 = -p_j U_h'(c^h) + \beta^h E^h \{ f_j^+ U_h'(c^{h+}) \} + \eta_j^h(-)$$

$$0 = \phi_j^h(+) \eta_j^h(+)$$

$$0 = \phi_j^h(-) \eta_j^h(-).$$

Notice that for the case of assets with fixed supply,  $q_a^* = q_a$ .

**Definition 3** A Markov equilibrium consists of a (non-empty valued) 'policy correspondence',  $P$ , and a transition function  $F$

$$P : \mathcal{S} \times \Omega \times E \rightrightarrows \widehat{\mathcal{V}}$$

and

$$F : \text{graph}(P) \longrightarrow \mathcal{V}^{\mathcal{S}}$$

such that  $\text{graph}(P) \subset \mathcal{X}$  and for all  $x \in \text{graph}(P)$  and all  $s \in \mathcal{S}$  we have  $F(x) \subset g(x)$  and  $(s, F_s(x)) \in \text{graph}(P)$ .

**Lemma 1** *A Markov equilibrium is a incomplete markets equilibrium according to Definition 1.*

**Proof.** This result is similar to the one in Duffie, Geanakoplos, Mas-Colell, and McLennan (1994). We only need to show that the first order conditions as represented by Lagrange multipliers are sufficient to ensure the optimal solution of the consumers. This holds because the optimization each consumer faces is a convex maximization problem. ■

Before continue, let me briefly discuss asset prices and real investment in a Markov equilibrium.

Notice that in (22),  $q_{a,t}^* = q_{a,t}$  for assets in fixed-supply. We can rewrite that first-order condition with respect to asset holding (22) as

$$q_a U'_h(c^h) = \mu_a^h + \beta_h E^h \{ (q_a^+ + d_a^+) U'_h(c^{h+}) \} \geq \beta_h E^h \{ (q_a^+ + d_a^+) U'_h(c^{h+}) \}.$$

By re-iterating this inequality we obtain

$$q_{a,t} \geq E_t^h \left\{ \sum_{r=1}^{\infty} \beta_h^r d_{t+r} \frac{U'_h(c_{t+r}^h)}{U'_h(c^h)} \right\}.$$

We have a strict inequality if there is a strict inequality  $\mu_{a,t+r}^h > 0$  in future. So the asset price is higher than the discounted value of the stream of its dividend because in future it can be sold to other agents, as in Harrison and Kreps (1978) or it can be used as collateral to borrow as in Fostel and Geanakoplos (2008). Proposition 2 shows some conditions under which collateral constraints will eventually be binding for every agents when they strictly differ in their belief. As a results, asset price is strictly higher than the discounted value of dividends.

Equation (22) also shows that asset  $a$  will have collateral value when some  $\mu_a^h > 0$ , in addition to the asset's traditional pay-off value weighted at the appropriate discount factors. Unlike in Alvarez and Jermann (2000), attempts to find a pricing kernel which prices assets using their pay-off value might prove fruitless because assets with the same pay-offs but different collateral values will have different prices. This point is also emphasized in Geanoplos's papers.

For asset with elastic supply, the same equation (22) implies that the value of one unit of capital is increasing in the collateral value associated to the multiplier on the collateral constraints and short-sale constraints  $\mu_a^h$ . Moreover when we derive the first-order of the capital producer's optimization problem using the form (2) we have

$$q_{a,t}^* \Phi' \left( \frac{I_{a,t}}{K_{a,t}} \right) = 1.$$

Given the concavity of  $\Phi$ , this equation shows that the aggregate real investment,  $I_{a,t}$ , in asset  $a$  is an increasing function of asset price  $q_{a,t}^*$  as in Tobin's Q theory of investment.

### 3.3 Existence and Properties of Markov equilibrium

The existence proof is based on Kubler and Schmedders (2003) and Magill and Quinzii (1994): approximating the Markov equilibrium by a sequence of equilibria in finite horizon. There

are three steps in the proof. First, using Kakutani fixed point theorem to prove the existence proof of the truncated T-period economy. Second, show that all endogenous variables are bounded. And lastly, show that the limit as T goes to infinity is the equilibrium of the infinite horizon economy.

However, the most difficult part, including in the two related papers, is to prove the second step and this step involves the most of problem-specific economics intuitions. Basically showing that quantities are bounded is easy (with collateral constraint especially), but showing prices are bounded is more challenging. For example, what are the upper bounds of prices of long-lived assets? These prices may well exceed the current aggregate endowment. With capital investment, we also have to bound the total supply of elastic-supply capital. I get around this difficulty by using the usual assumption in the neoclassical growth model: assuming capital depreciates and strictly concave production functions, then combine it with the artificial compact boxes trick in Debreu (1959).

**Lemma 2** *Consider a finite horizon economy that last  $T+1$  periods  $t = 0, 1, \dots, T$ , identical to infinite horizon economy excepts consumers maximize the expected utility over  $T+1$  periods*

$$E_0^h \left[ \sum_{t=0}^T \beta_h^t U_h(c_t) \right]$$

and in the last period  $t = T$ , there are no financial markets. In the first period, the budget constraint of agents  $h$  is

$$\begin{aligned} c_0 + \sum_{a \in \mathcal{A}_0} q_{a,0}^* k_{a,0} + \sum_{a \in \mathcal{A}_1} q_{a,0} k_{a,0} + \sum_{j=1}^J p_{j,0} \phi_{j,0} \leq e_0^h + \sum_{a \in \mathcal{A}_0} w_{a,0} l_{a,0} \\ + \omega_0^h \sum_{a \in \mathcal{A}} (q_{a,0} + d_{a,0}) K_{a,-1} \end{aligned} \tag{23}$$

instead of (7). An equilibrium exists given any initial condition

$$(s_0 \in \mathcal{S}, \omega_0 \in \Omega, \{K_{a,-1}\}_{a \in \mathcal{A}}).$$

Instead of the usual budget constraints using in recursive equilibria, we use the condition that each consumer holds a share of the final total value of assets. This sharing can be implemented by assuming each agent  $h$  holds exactly  $\omega_0^h$  share of each asset  $a \in \mathcal{A}$ .

**Proof.** The proof follows the steps in Debreu (1959) using Kakutani's fixed point theorem and is presented in the Appendix. However it uses a different definition of attainable sets. Indeed, in Definition 4 in the Appendix, negative excess demand (instead of zero excess demand as in the original text) is enough to guarantee the boundedness of the equilibrium allocations. In addition, I will also show that prices are strictly positive. ■

To prove that the Markov equilibrium exists, we need to first show that there exists a compact set in which finite horizon equilibria lie. We need the following three additional assumptions:

**Assumption 6** *There exists a  $\bar{K}_a > 0$  for each  $a \in \mathcal{A}_0$  such that*

$$\Psi_a(\bar{K}_a, \bar{K}_a) \geq \max_{s \in \mathcal{S}} \bar{e}_a(s), \quad (24)$$

where

$$\begin{aligned} \bar{e}_a(s) &= \sum_{h=1}^H e^h(s) + \sum_{a' \in \mathcal{A}_1} d_{a'}(s) K_{a,0} + \sum_{a' \in \mathcal{A}_0} F_{a'} \left( \bar{K}_{a'}, \sum_{h=1}^H L_{a'}^h, s \right) \\ &+ \sum_{a' \in \mathcal{A}_0 \setminus \{a\}} \Psi_{a'}(0, \bar{K}_{a'}) \end{aligned}$$

**Assumption 7** *The first-derivative of  $\Psi_a$  are bounded over  $[0, \bar{K}_a]^2$ .*

The first assumption ensures that total quantities of elastic-supply assets are bounded. For example, when we have only one elastic-supply asset and its supply is perfectly elastic, i.e., adjustment cost function is given by the flexible investment function (1) and the associated production is Cobb-Douglas with  $\alpha_a \in (0, 1)$ . Then inequality (24) is equivalent to

$$\delta_a \bar{K}_a > \text{const} + A (\bar{K}_a)^{\alpha_a} L_a^{1-\alpha_a}$$

which must be true for  $\bar{K}_a$  large enough. This is also the way one obtains a upper bound for capital in a neoclassical growth model. The second assumption, ensures that prices of new and old assets are bounded in equilibrium as they correspond to the first-derivatives of  $\Psi_a$ . For example, (1) gives

$$\begin{aligned} \frac{\partial \Psi_a(K_a^n, K_a^o)}{\partial K^n} &= 1 \\ \frac{\partial \Psi_a(K_a^n, K_a^o)}{\partial K^o} &= -(1 - \delta_a). \end{aligned}$$

Remind that  $\bar{e}$  is defined in (12).

**Assumption 8** *There exist  $\bar{c}, \underline{c} > 0$  such that*

$$\begin{aligned} &U_h(\underline{c}) + \max \left\{ \frac{\beta_h}{1 - \beta_h} U_h(\bar{e}), 0 \right\} \\ \leq &\min \left\{ \frac{1}{1 - \beta_h} \min_{s \in \mathcal{S}} U_h(\underline{e}), \min_{s \in \mathcal{S}} U_h(\underline{e}) \right\} \quad \forall h \in \mathcal{H}. \end{aligned} \quad (25)$$

and

$$\begin{aligned} &U_h(\bar{c}) + \min \left\{ \frac{\beta_h}{1 - \beta_h} U_h(\underline{e}), 0 \right\} \\ \geq &\max \left\{ \frac{1}{1 - \beta_h} U_h(\bar{e}), U_h(\bar{e}) \right\} \quad \forall h \in \mathcal{H}. \end{aligned} \quad (26)$$



The intuition for (25) is detailed in the proof of proposition 1; it ensures a lower bound for consumption. (26) ensures that prices of assets with fixed supply are bounded from above. When there are only assets with elastic supply, the second inequality (26) is not needed. Both inequalities are obviously satisfied by log utility.

**Lemma 3** *Suppose Assumptions 6, 7 and 8 are satisfied then there is a compact set that contains the equilibrium endogenous variables constructed in Lemma 2 for every  $T$  and every initial condition lying inside the set.*

**Proof.** Appendix. ■

**Theorem 2** *Under the same conditions, a Markov equilibrium exists.*

**Proof.** Appendix. As in Kubler and Schmedders (2003), we extract a limit from the T-finite horizon equilibria. Lemma 3 guarantees that equilibrium prices and quantities are bounded as T goes to infinity. ■

**Corollary 2** *In a Markov equilibrium, every consumer survives.*

**Proof.** From the construction of the equilibrium  $c^h(s^t) > \underline{c}$  for all  $h, t, s^t$ . ■

**Corollary 3** *The Markov equilibrium is Pareto-inefficient if agents strictly differ in their beliefs.*

**Proof.** In Proposition 1 we show that under complete market, i.e. Pareto efficient allocation, consumption of some agents get arbitrarily close to zero in some history. Given the lower bound on consumption of each Markov equilibrium, an allocation corresponding to a Markov equilibrium is not a complete markets allocation. Therefore it is not a Pareto efficient allocation. ■

**Proposition 6** *In contrast to the complete markets benchmark, in these Markov equilibria, asset prices can be history-dependent.*

**Proof.** The realizations of aggregate shocks determine the evolution of the wealth distribution which is one factor that determines asset prices. ■

**Proposition 7** *When aggregate endowment and aggregate productivity are constant, and shocks are I.I.D, long run asset price volatility and investment volatility are higher under incomplete markets than they are under complete markets.*

**Proof.** In the long run, under complete markets, the economy converges to the one with homogenous beliefs because agents with incorrect beliefs will eventually be driven out of the markets. We can thus find a representative agent. Standard arguments for representative agent economy imply that asset prices are constant and levels of investment converge to their steady state levels. For example, suppose we only have assets in fixed-supply and the

aggregate endowment is independent of states:  $e(s_t) = e$ . Then, in equation (17) for the long run representative agent, we can divide both side of that equation by  $U'_{\text{Rep}}(e)$  to obtain

$$\begin{aligned} q_a(s^t) &= E_t^{\text{Rep}} \left\{ \sum_{r=1}^{\infty} d_a(s_{t+r}) \beta^r \right\} \\ &= \frac{\beta}{1-\beta} E_t^{\text{Rep}} \{d_a(s_{t+1})\}. \end{aligned}$$

From the first to the second line, I use the fact that the dividends process is I.I.D. The last equality implies that asset price  $q_a(s^t)$  is independent of time and state.

When we have assets in elastic supply, but with constant productivity, as in the neoclassical growth model, the total quantity of an asset  $a$  in fixed supply should converge to the steady-state level  $K_a^*$  which is determined by the

$$\frac{\partial \Psi_a(K_a^*, K_a^*)}{\partial K_a^n} = \beta \left( -\frac{\partial \Psi_a(K_a^*, K_a^*)}{\partial K_a^o} + F_{a,K}(K_a^*, L_a) \right)$$

and therefore the investment associated to this asset converges to  $I_a^* = \Psi_a(K_a^*, K_a^*)$ .

Hence, under complete markets, asset price volatility and investment volatility converge to zero in the long run. Under incomplete markets, asset price volatility and investment volatility remain well above zero as aggregate shocks constantly change the wealth distribution, which, in turn, changes asset prices and investment. ■

There are two components of asset price volatility. The first one comes from volatility in the dividend process and aggregate endowment. The second one comes from wealth distribution, when agents strictly differ in their beliefs. However, the second component disappears under complete markets because only agents with correct beliefs survive in the long run. Whereas, under incomplete markets, this component persists. As a result, when we shut down the first component, asset price is more volatile under incomplete markets than it is under complete markets in the long run. In general, the same comparison holds or not depending on the long-run correlation between the first and the second volatility components under incomplete markets.

### 3.4 Relationship to recursive equilibria

When we do not have financial assets and there is only one real asset, then Markov equilibria are recursive equilibria. This is also true when initially agents hold the same fraction of each assets. However, in general, Markov equilibria are not recursive equilibria. But in Kubler and Schmedders (2003), subsection 4.4 shows that we can construct recursive equilibria from Markov equilibria if we can extract a continuous mapping from the policy correspondence.

As an important special case discussed after Definition 1 of incomplete markets equilibrium, the economy in Krusell and Smith (1998) corresponds to the economy here with one asset in perfectly elastic supply and without financial markets. The existence of a Markov equilibrium implies the existence of recursive equilibrium. Indeed, given that there is no financial markets and only one asset. The "normalized financial wealth"  $\omega_t^h$  becomes  $\frac{k_{a,t-1}^h}{K_{a,t-1}}$  the fractions of capital asset holdings. Together with the total quantity of capital,  $K_{a,t}$ , the

state variables  $(s_t, \omega_t, K_{a,t-1})$  is equivalent to  $(s_t, (k_{a,t-1}^h))$ , the aggregate state and capital holdings of each agent in the definition of recursive equilibrium in page 874 of Krusell and Smith (1998). In a recent paper, Miao (2006) shows the existence of recursive equilibrium however he has to include future expected discounted utilities of agents in the state-space. In addition, he wrote in page 291, that the question whether a recursive equilibrium in Krusell and Smith (1998) exists remains an open question. The existence proof here provides a positive answer to that question. However, in this paper I only consider a finite number of types.

## 4 Numerical Method

In this section, I present an algorithm to compute Markov equilibria defined in the last section. This algorithm can also be used to compute complete markets equilibria.

### 4.1 General Algorithm

Suppose we need to find a function  $\rho$  defined over  $S \times E$  on to a compact set  $A \subset \mathbf{R}^N$ , where  $S$  has finite element and  $E$  is convex and compact, and  $\rho$  satisfies the functional equation

$$\rho = f + T\rho$$

We then first discretize  $E$  by  $\{e_1, e_2, \dots, e_K\}$ , and  $\rho^n = (\rho_1^n, \rho_2^n, \dots, \rho_S^n)$ , each component is defined over  $\{e_1, e_2, \dots, e_K\}$ . Let  $\tilde{\rho}_s^n$  be the extrapolation of  $\rho_s^n$  over  $E$ . Then

$$\rho_s^{n+1}(e_k) = \arg \min_{r \in A} \|r - \{f(e_k) + T\tilde{\rho}_s^n(e_k)\}\| \quad (27)$$

If we have a fixed point  $\rho^{n+1} = \rho^n$  and  $f(e_k) + T\tilde{\rho}_s^n(e_k) \in A$  then

$$\rho_s^n(e_k) = f(e_k) + T\tilde{\rho}_s^n(e_k)$$

We present an implementation of this general algorithm to compute Markov Equilibria. We can also use the algorithm to compute competitive equilibria with complete markets. The state space in this case is the current consumption of each agent and the total supply of assets with elastic supply. The details are presented in the Appendix.

### 4.2 Algorithm to Compute Markov Equilibria

The construction of Markov equilibria in the last section also suggests an algorithm to compute them. The following algorithm is based on Kubler and Schmedders (2003). There are two differences of the algorithm here compared to the original algorithm. The more important difference is that the future wealth distributions are included into the current mapping instead of solving for them using a sub-fixed-point loops. This innovation reduces significantly the computing time, given solving for a fixed-point is time consuming in MATLAB. Relatedly, in section 5, as we seek to find the set of actively traded financial assets, we can include future asset prices as one of the components of the function  $\rho$ . The minor difference

between the algorithm presented in Kubler and Schmedders (2003) and the one here is, for each iteration, I solve for a constrained optimization problem presented in (27) instead of solving for a zero point as in the original algorithm. This difference avoids the non-existence of zero points at the beginning of the loop when the initial guess  $\rho^0$  is far away from the true solution.

We look for the following correspondence

$$\begin{aligned} \rho : \mathcal{S} \times \Omega \times E &\longrightarrow \widehat{\mathcal{V}} \times \Omega^S \times \mathcal{L} \\ (s, \omega, K_a) &\longmapsto (\widehat{v}, \omega_s^+, \mu, \eta) \end{aligned} \quad (28)$$

$\widehat{v} \in \widehat{\mathcal{V}}$  is the set of endogenous variables excluding the wealth distribution and total capital, as defined in (18).  $(\omega_s^+)_{s \in \mathcal{S}}$  are the wealth distributions in the  $S$  future states and  $\mu, \eta$  are Lagrange multipliers as defined in subsection 3.2.

From a given continuous initial mapping  $\rho^0 = (\rho_1^0, \rho_2^0, \dots, \rho_S^0)$ , we construct the sequence of mappings  $\{\rho^n = (\rho_1^n, \rho_2^n, \dots, \rho_S^n)\}_{n=0}^\infty$  by induction. Suppose we have obtained  $\rho^n$ , for each state variable  $(s, \omega, K_a)$ , we look for

$$\rho_s^{n+1}(\omega, K_a) = (\widehat{v}_{n+1}, \omega_{s,n+1}^+, \mu_{n+1}, \eta_{n+1}) \quad (29)$$

that solves the forward equations presented in the Appendix.

We construct the sequence  $\{\rho^n\}_{n=0}^\infty$  on a finite discretization of  $\mathcal{S} \times \Omega \times E$ . So from  $\rho^n$  to  $\rho^{n+1}$ , we will have to extrapolate the values of  $\rho^n$  to outside the grid using extrapolation methods in MATLAB. Fixing a precision  $\delta$ , the algorithm stops when  $\|\rho^{n+1} - \rho^n\| < \delta$ .

## 5 Asset price volatility and leverage

This section uses the algorithm just described to compute incomplete and complete markets equilibria and study asset price and leverage. In order to focus on asset price, I only keep one real asset in fixed supply. Each financial asset corresponds to a leverage level. Suppose selling financial asset  $j$  requires  $k_j$  units of the fixed-supply asset as collateral and price of  $j$  is  $p_j$ . This operation is equivalent to buy  $k_j$  units of the real asset, at price  $q$  with  $p_j$  borrowed. Therefore, leverage as defined in Geanakoplos (2009) by the ratio between total value of the real asset over the down payment paid by the buyer:

$$L_j = \frac{k_j q}{k_j q - p_j} = \frac{q}{q - \frac{p_j}{k_j}}.$$

If in equilibrium, only one financial asset  $j$  is traded, the leverage level corresponding to the financial asset is called the leverage level of the economy.

To make the analysis as well as numerical procedure simple, I allow for only one asset and two types of agents: optimists and pessimists, each in measure 1 of identical agents. The general framework in Section 2 allows for wide range of financial assets with different promises and collateral requirements. However, given that the total quantity of collateral is exogenously bounded, in equilibrium, only certain financial assets are actively traded. I choose a specific setting based on Geanakoplos (2009), in which I can find exactly which

assets are traded. The setting requires that promises are state-incontingent and in each aggregate state there are only two possible future aggregate states. The assets that are traded are the assets that allow maximum borrowing while keeping the payoff to lenders riskless. Endogenous financial assets interestingly generates the most volatility in the wealth distribution as agents borrow to the maximum and lose most of their wealth as they lose their bets but their wealth increases largely when they win. This volatility in the wealth distribution in turn feeds in to asset price volatility.

Endogenous set of traded assets also implies endogenous leverage which has been of the object of interest during the current financial crisis. In order to match the observed pattern of leverage, i.e., high in good states and low in bad states, I introduce the possibility for changing types of uncertainty from one aggregate state to others. This feature is introduced in Subsection 5.2.4.

To answer questions related to collateral requirements, in Subsection 5.2.5, I allow regulators to control the sets of financial assets that can be traded. Given the restricted set, the endogenous active assets can still be determined. One special case is the extreme regulation that shuts down financial markets. There are surprising consequences of these regulations on welfare of agents, on the equilibrium wealth distribution and on asset prices.

## 5.1 The model

There are two aggregate states  $s = G$  or  $B$  and one single asset of which the dividend depends on the state  $s$

$$d(G) > d(B).$$

The state follows a I.I.D process, with the probability of high dividends  $\pi$  unknown to agents in this economy. However the transition matrix is unknown to the agents in this economy. The supply of the asset is exogenous and normalized to 1. Let  $q(s^t)$  denote the ex-dividend price of the asset at each history  $s^t = (s_0, s_1, \dots, s_t)$ .

**Financial Markets:** At each history  $s^t$ , we consider the set of  $J$  of financial assets which promise state-independent pay-offs next period. I normalize these promises to  $b_j = 1$ . Asset  $j$  also requires  $k_j$  units of the real asset as collateral. The effective pay-off is therefore

$$f_{j,t+1}(s^{t+1}) = \min \{1, k_j (q(s^{t+1}) + d(s^{t+1}))\}$$

Fostel and Geanakoplos (2008), Geanakoplos (2009) and recently Simsek (2009b) argue that if we allow for the set  $J$  to be dense enough that contains the complete set of collateral requirements, then in equilibrium the only financial asset is traded is the one with the minimum collateral level  $k^*(s^t)$  to avoid default:

$$k^*(s^t) = \max_{s^{t+1}|s^t} \left\{ \frac{1}{q(s^{t+1}) + d(s^{t+1})} \right\}.$$

This statement applies for my general set up under the condition that in each history node, there are only two future aggregate states. The following proposition makes it clear.

**Proposition 8** *Suppose in each event node  $s^t$ , there are only two possible future aggregate states  $s_{t+1}$ . Given the set  $J$ , there is no more than one actively traded asset with collateral requirement less than or equal to  $k^*(s^t)$ . There is also no more than one actively traded asset with collateral requirement greater than or equal to  $k^*(s^t)$ .*

**Proof.** The proof of the first part requires an analysis of portfolio choice of the sellers of these securities and is detailed in the Appendix. For the second part, notice that all securities with collateral greater than or equal to  $k^*(s^t)$  is riskless to the buyers, i.e. deliver 1 units of final good regardless of the future states. Hence, these securities are sold at the same price. In addition, the sellers of the securities prefer selling securities with the least level collateral requirement to save their collateral. Therefore in equilibrium, only one security, with the collateral requirement the smallest above  $k^*(s^t)$ , is traded. ■

Imagine that the set  $J$  includes all collateral requirements  $k_j \in \mathbf{R}^+, k_j > 0$ .<sup>12</sup> Proposition 8 says that only securities with collateral requirement exactly equals to  $k^*(s^t)$  are traded in equilibrium. Therefore the only actively traded financial asset is riskless to its buyers. Let  $p(s^t)$  denote the price of this financial asset. The endogenous interest rate is therefore

$$r(s^t) = \frac{1}{p(s^t)} - 1.$$

**Consumers:** There are two types agents in this economy, optimists, O, and pessimists, P, each in measure one of identical agents. They have the same utility function

$$\sum_{t=0}^{\infty} \beta^t U(c_t), \quad (30)$$

and endowment  $e$  in each period. But they differ in their belief about the transition matrix of the aggregate state  $s$ . Suppose agent  $h \in \{O, P\}$  estimates the probability of high dividends as  $\pi_G^h = 1 - \pi_B^h$ . We suppose  $\pi_G^O > \pi_G^P$ , i.e. optimists always think that good states are more likely than the pessimists think they are.

So each agent maximizes the inter-temporal utility (30) given their belief of the evolution of the aggregate state, they are subject to

$$c_t + q_t \theta_t + p_t \phi_t \leq e_t + (q_t + d_t) \theta_{t-1} + f_t \phi_{t-1} \quad (31)$$

no short-sale

$$\theta_t \geq 0 \quad (32)$$

and collateral constraint

$$\theta_t + \phi_t k^* \geq 0, \quad (33)$$

for each  $h \in \{O, P\}$ . At time  $t$ , each agent choose to buy  $\theta_t$  units of real asset at price  $q_t$  and  $\phi_t$  units of financial asset at price  $p_t$ . Moreover, Proposition 8 allows us to focus on only one level of collateral requirement  $k^*$ .

<sup>12</sup>To apply the existence theorem 2 I need  $J$  to be finite. But we can think of  $J$  as a fine enough grid.

Given prices  $q$  and  $p$ , this program yields solution  $c_t^h(s^t), \theta_t^h(s^t), \phi_t^h(s^t)$ . In equilibrium prices  $\{q_t(s^t)\}$  and  $\{p_t(s^t)\}$  are such that asset and financial markets clear, i.e.,

$$\begin{aligned}\theta_t^O + \theta_t^P &= 1 \\ \phi_t^O + \phi_t^P &= 0\end{aligned}$$

for each history  $s^t$ .

I define the financial wealth of each agent at the beginning of each period as

$$\omega_t^h = \frac{(q_t + d_t)\theta_{t-1}^h + f_t\phi_{t-1}^h}{q_t + d_t}.$$

Due to the collateral constraint, in equilibrium,  $\omega_t^h$  must always be positive and

$$\omega_t^O + \omega_t^P = 1.$$

The pay-off relevant state space

$$\{(\omega_t^O, s_t) : \omega_t^O \in [0, 1] \text{ and } s_t \in \{G, B\}\}$$

is compact. I look for Markov equilibria in which prices and allocations depend solely on that state. In Sections 2 and 4, I show the existence of such a Markov equilibrium and develop an algorithm that computes the equilibrium.

## 5.2 Numerical Results

Numerical example

$$\begin{aligned}\beta &= 0.5 \\ d(G) &= 1 > d(B) = 0.2 \\ U(c) &= \log(c)\end{aligned}$$

And the beliefs are  $\pi^O = 0.9 > \pi^P = 0.5$ . I will vary the endowments of the optimists and the pessimists,  $e^O$  and  $e^P$  respectively, in different numerical exercises.

### 5.2.1 Asset Prices

Given that the main demand for the asset comes from the optimists, when their endowment is small, their demand is more elastic with respect to "normalized financial wealth". To investigate that relationship, I fix the endowment of the pessimists at

$$e^P = [10 \quad 10.8]$$

and vary the endowment of the optimist

$$e^O = [e \quad e]$$

I keep the aggregate endowment constant by choosing the pessimists' endowment to be state dependent.

*Incomplete Markets Equilibrium:* I rewrite the budget constraint of the optimists (31) using the normalized financial wealth,  $\omega^O$ ,

$$c_t + q_t\theta_t + p_t\phi_t \leq e^O + (q_t + d_t)\omega^O.$$

Therefore, their total wealth  $e^O + (q_t + d_t)\omega^O$  affects their demand for the asset. If non-financial endowment  $e^O$  of the optimists is small relative to price of the asset, their demand for asset is more elastic with respect to their financial wealth  $(q_t + d_t)\omega^O$ . I compute Markov equilibria for two values of the optimists' wealth  $e = 1$  and 10. Figure 1 plots price of the asset as function of the optimists' normalized financial wealth  $\omega^O$ . The dashed line corresponds to the high "non-financial" wealth of the optimists:  $e^O = 10$ ; the solid line corresponds to low the low "non-financial" wealth of the optimists:  $e^O = 1$ . The figure shows that the elasticity of price with respect to  $\omega^O$  increases as we reduce the non-financial wealth of the optimists from  $e^O = 10$  to  $e^O = 1$ .

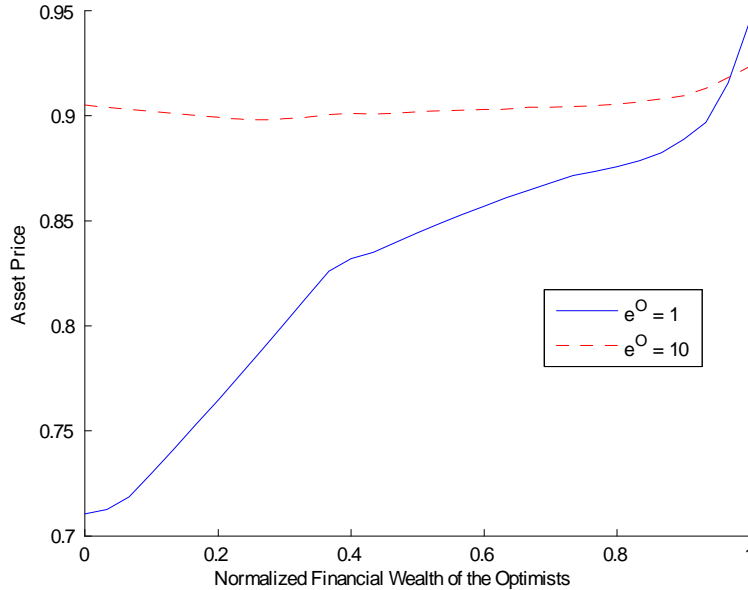

Figure 1: Asset Price Under Incomplete Markets

There are two main factors that affect asset prices. The first factor is the aggregate state. Aggregate states affect prices through endowments of agents. Because their endowments determine their consumption, and thus determine the marginal utility at which they evaluate value of the asset. Aggregate states also affect asset prices through the evolution of future aggregate states, if these states are persistent. The second factor that I emphasize here is the financial wealth distribution, as it affects the budget constraints of different agents. The financial wealth distribution may vary significantly, especially when some agents have limited non-financial wealth. Figure 2 shows the evolution of the "normalized financial wealth" of the optimists,  $\omega^O$ , when their non-financial endowment is relatively small with respect to the price of the asset:  $e^O = 1$ . The left panel corresponds to the current state  $s = G$ , and



the right panel corresponds to the current state  $s = B$ . The solid lines represent next period normalized wealth of the optimists as function of the current normalized wealth, if good shock realizes next period. The dashed lines represent the same function when bad shocks realizes next period. I also plot the 45 degree lines for comparison. This figure shows that, in general, good shocks tend to increase and bad shocks tend to decrease the normalized wealth of the optimists.

When  $\omega^O$  is close to zero, the optimists are highly leveraged to buy the asset. If a bad shocks hits in the next period, they have to sell off their asset holdings to pay off their debts. Their next period "financial wealth" plummets and contributes to the fall in asset price.

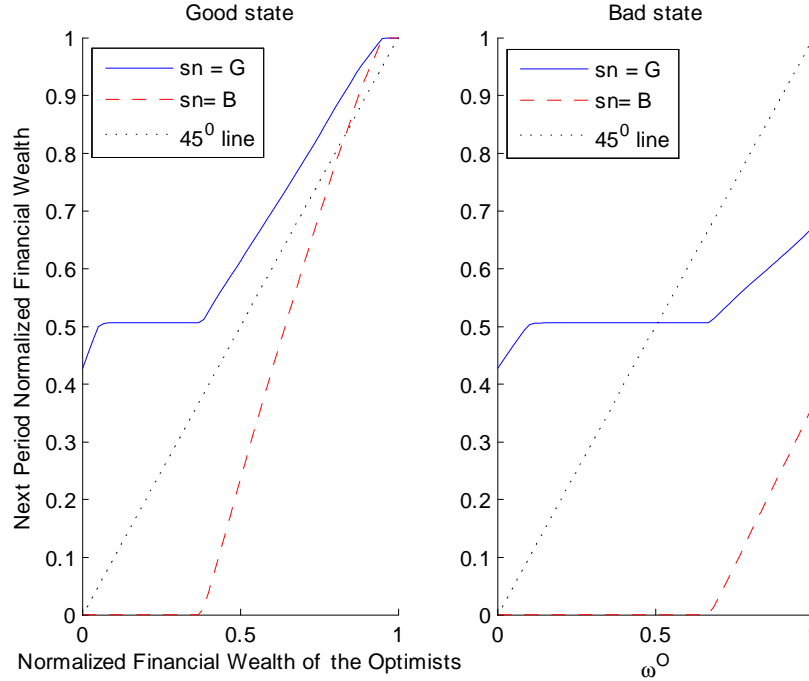

Figure 2: Dynamics of Wealth Distribution under Incomplete Markets

*Complete Markets Equilibrium:* In a complete markets equilibrium, as shown in the Appendix, remark 1, the state variable is the consumption of the optimists. However, there is a one-to-one mapping from this state variable to a more meaningful state variable which is the relative wealth of the optimists. Given that markets are complete, wealth of each consumer is defined as the current value of her current and future stream consumption

$$V_t^h = \sum_{r=0}^{\infty} p_t(s^{t+r}) c_{t+r}^h(s^{t+r}),$$

where  $p_t(s^{t+r})$  denotes the time  $t$  Arrow-Debreu price for a claim to a unit of consumption at date  $t+r$  and state  $s^{t+r}$ . Let

$$\hat{\omega}_t^O = \frac{V_t^O}{V_t^O + V_t^P}$$

denote the relative wealth of the optimists with respect to the total wealth. Similar to the incomplete markets equilibrium, this variable determines asset price and constantly changes as aggregate shocks hit the economy. Figure 3 depicts the relationship between asset price and relative wealth. This figure is the counterpart of Figure 1 for complete markets.

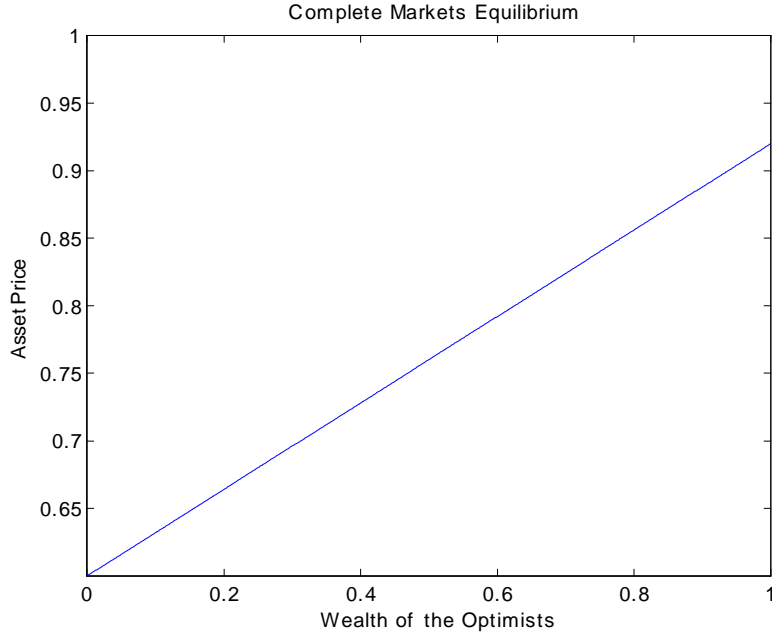

Figure 3: Asset Price under Complete Markets

Notice that at two extreme  $\hat{\omega}_t^O = 0$  (on the left of Figure 3) or 1 (on the right of Figure 3), we go back to the representative agent economy in which there are either only the optimists or the pessimists. The representative consumer consumes all the aggregate endowment in each period. Asset price is determined by her marginal utility.

$$q(s) U'(e(s)) = \sum_{s'} \beta P(s, s') U'(e(s')) (q(s') + d(s'))$$

so, we can rewrite these equations as

$$\begin{bmatrix} q(G) \\ q(B) \end{bmatrix} = X^{-1}Y \begin{bmatrix} d(G) \\ d(B) \end{bmatrix} \quad (34)$$

where  $X$  and  $Y$  are matrices with elements that are functions of marginal utilities and transition probabilities. This formula also suggests that volatility of price of an asset is proportional to volatility of its dividends if  $X^{-1}Y$  is state-independent.

Consider a special case when the aggregate endowments are constant across states and shocks are I.I.D, we have

$$q(G) = q(B) = \frac{\beta}{1 - \beta} (P(G) d(G) + P(B) d(B)),$$

i.e., asset price is constant in the long run. When  $\widehat{\omega}_t^O = 0$ , asset price is the discounted value of average dividends evaluated at the pessimists' belief

$$q^P = \frac{\beta}{1 - \beta} (\pi^P d(G) + (1 - \pi^P) d(B)),$$

which is smaller than when  $\widehat{\omega}_t^O = 1$ , where asset price is the discounted value of average dividends evaluated at the optimists' belief

$$q^O = \frac{\beta}{1 - \beta} (\pi^O d(G) + (1 - \pi^O) d(B)) > q^P.$$

In the short-run, however, the wealth distribution constantly changes as shocks hit the economy. Figure 4 depicts the evolution of the relative wealth distribution that determines the evolution of asset price under complete markets. This figure is the counterpart of Figure 2 under complete markets. Given that the aggregate endowment is constant, the transition of the wealth distribution does not depend on current aggregate state, unlike under incomplete markets. The optimists buy more Arrow-Debreu assets that deliver in the good future states and buy less Arrow-Debreu assets that delivers in bad future states. Therefore, when a good shock hits, the relative wealth of the optimists increases (solid line) and vice versa when a bad shock hits (dashed line).

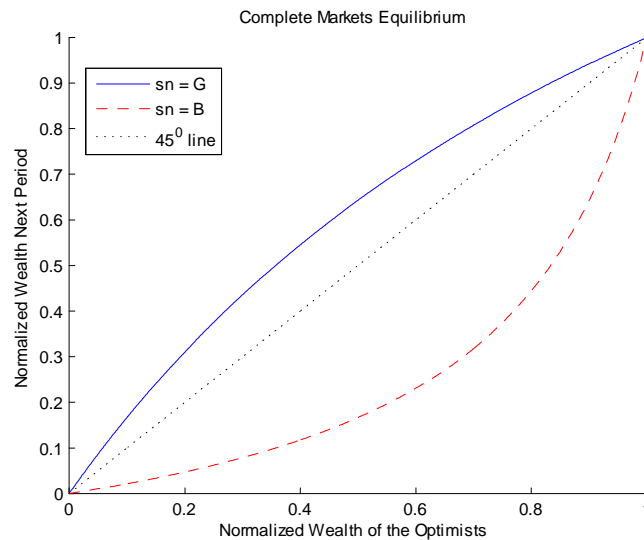

Figure 4: Dynamics of Wealth Distribution under Complete Markets

### 5.2.2 Asset Price Volatility

We compare asset prices, and asset price volatility of the Markov equilibrium with the complete markets benchmark. Consider first what happens with complete markets: Asset price does depend on the wealth distribution  $\widehat{\omega}_t^O$  and its evolution. However, in the long run

$\hat{\omega}_t^O$  converges to 0 or to 1 depending on whether the pessimists or the optimists hold the correct belief. Therefore, in the long run, asset price only depends on the aggregate states.

In the case of Markov equilibrium, however, consumers with incorrect beliefs are protected by the no default penalty assumption. They always survive in equilibrium, and constantly speculate on asset prices. First, asset prices are not only state dependent but also depend on the wealth of the optimists. Second, their wealth undergoes large swings as they lose or win their bet after each period. The two components increase the volatility of asset price compared to the complete markets case.

I measure price volatility as one-period ahead standard deviation of price. This measure is the discrete time equivalence of the continuous instant volatility, see for example Xiong and Yan (2009). The following figure shows the evolution of asset price volatility under the assumption that the pessimists hold the correct belief. The figure shows that, in short run, asset price is more or less volatile in the complete markets equilibrium than in the incomplete markets economy depending on the relative non-financial wealth of agents. However, in the long run, as the optimists are driven out in the complete markets equilibrium, asset price is history independent and price volatility is proportional to dividend volatility. This property does not hold in the incomplete markets equilibrium, the overly optimistic agents constantly speculate on asset price using the same asset as collateral. Asset price becomes more volatile than in the complete markets equilibrium, given the wealth of the optimists constantly change as they win or loose their bets.

Strikingly, the smaller the non-financial wealth of the optimist is, the higher the short-run asset price volatility in the incomplete markets equilibrium but the lower the short-run asset price volatility in the complete markets equilibrium. This is because, incomplete markets, it takes less time to drive out the optimists if they have lower non-financial wealth. As we increase the non-financial wealth of the optimists, we increase the short-run volatility of asset price with complete markets and decrease the short-run volatility of asset price with incomplete markets. Figure 5 plots the average asset price volatility over time for complete markets (dashed lines) and for incomplete markets (solid lines) equilibria, with different levels of "non-financial wealth" of the optimists (low and high). This figure shows that, above some certain level of non-financial wealth of the optimists, in the short-run asset price is more volatile under complete markets. But in the long run, the reverse inequality holds (right panel).

### 5.2.3 The financial crisis 2007-2008

Geanakoplos (2009) argues that the introduction of CDS triggered the financial crisis 2007-2008. The reason is that the introduction of CDS moves the markets close to complete. CDS allow pessimists to leverage their pessimism about the assets. I do the same exercise here by simulating a financial markets equilibrium in its stationary state from time  $t = 0$  until time  $t = 50$ .<sup>13</sup> At  $t = 51$  markets suddenly become complete. In Figure 6 left panel plots asset price level and right panel plots asset price volatility over time. The simulation shows that, asset price decreases, but asset price volatility increases in the short run after the introduction of CDS. The reason for the fall in asset price is that the "pessimists can

---

<sup>13</sup>In order to generate high short-run asset price volatility, I choose a high level of the optimists' endowment  $e^O = 10$ .

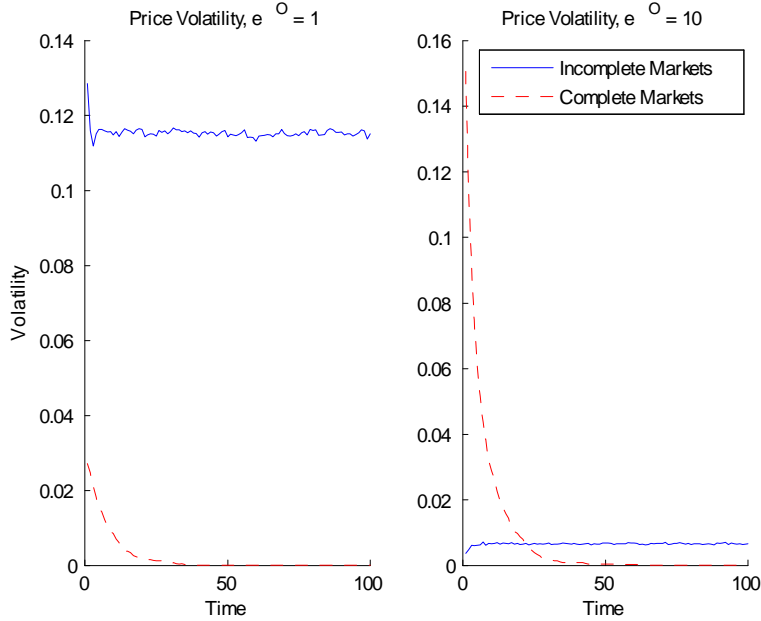

Figure 5: Asset Price Volatility Over Time

leverage their view". The reason for increasing in asset price volatility is the movement in the wealth distribution toward the long-run wealth distribution, which concentrates on pessimists. Asset price decreases because the pessimists can leverage their pessimism with complete markets.

#### 5.2.4 Dynamic leverage cycles

Even though the example in Subsection 5.2.2 generates high asset price volatility, leverage is not consistent with what we observe in financial markets: high leverage in good times and low leverage in bad times, as documented in Geanakoplos (2009).

In order to generate the procyclicality of leverage, I use the insight from Geanakoplos (2009) regarding aggregate uncertainty: bad news must generate more uncertainty and more disagreement in order to reduce equilibrium leverage significantly. To formalize this type of news, I assume that after a series of good shocks, the first bad shock does not immediately reduce dividends. After this bad shock, however, dividends plunge if a second bad shock hits the economy. Therefore the first bad shock increases uncertainty regarding dividends. In a dynamic setting, the formulation translates to a dividend process that depends not only on current aggregate shock but also on last period aggregate shock. Therefore we need to use four aggregate states, instead of the two aggregate states in the last subsections:

$$s \in \{GG, GB, BG, BB\}.$$

Figure 7, left panel, shows that the initial bad shocks following a series of good shocks does not reduce dividends. However, the fall in dividends increases, falling to 0.2, if a second bad shock hits the economy, i.e., the first bad shock increases uncertainty in dividends. The right

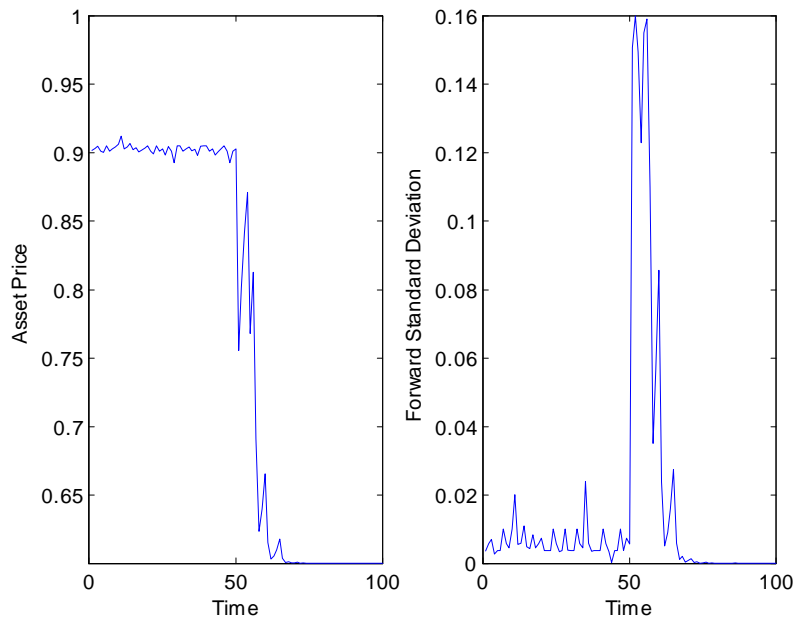

Figure 6: Financial Crisis 2007-2008

panel of the figure shows the evolution through time of the aggregate states using Markov chain representation.

This aggregate uncertainty structure generates high leverage at good states  $GG$  and  $BG$  and low leverage in bad states  $GB$  and  $BB$ . Figure 8 shows this pattern of leverage. The dashed line represents leverage level in good states  $s = GG$  or  $BG$  as a function of the normalized wealth distribution. The two solids lines represent leverage level in bad states  $s = GB$  or  $BB$ . We see that leverage decreases dramatically from good states to bad states. However, in contrast to the static version in Geanakoplos (2009), changes in the wealth distribution do not amplify the decline in leverage from good states to bad states as leverage is insensitive to the wealth distribution in bad states.

Moreover, this version of dynamic leverage cycles generates a pattern of leverage build-up in good times. Good shocks increase leverage as they increase the wealth of the optimists relative to the wealth of the pessimists and leverage is increasing the wealth of the optimists. Figure 9 shows the evolution of the wealth distribution and leverage over time. The economy starts at good state and  $\omega^O = 0$ . It experiences 9 consecutive good shocks from  $t = 1$  to 9 and two bad shocks at  $t = 10, 11$  then another 9 good shocks from  $t = 12$  to 20. This figure shows that, in good states, both the wealth of the optimists and leverage increase. However their wealth and leverage plunge when bad shocks hit the economy.

### 5.2.5 Regulating Leverage

Subsection 5.2.2 shows that, in a incomplete markets equilibrium, when the non-financial wealth of the optimists is small relative to asset prices, variations in their wealth play an

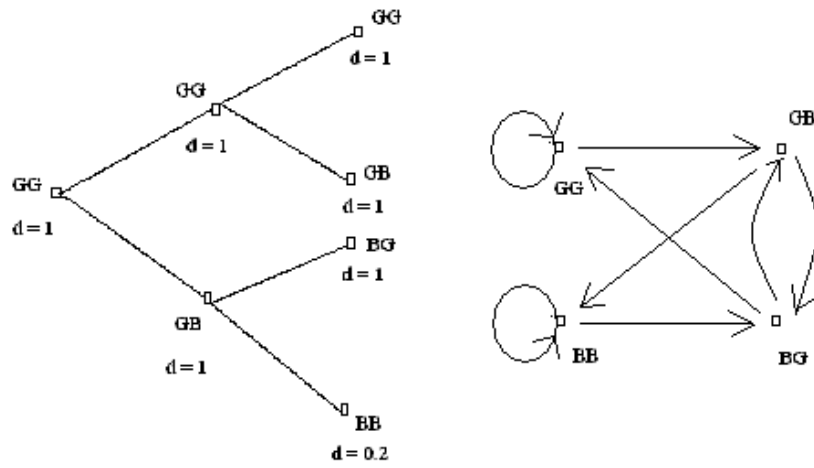

Figure 7: Evolution of the Aggregate States

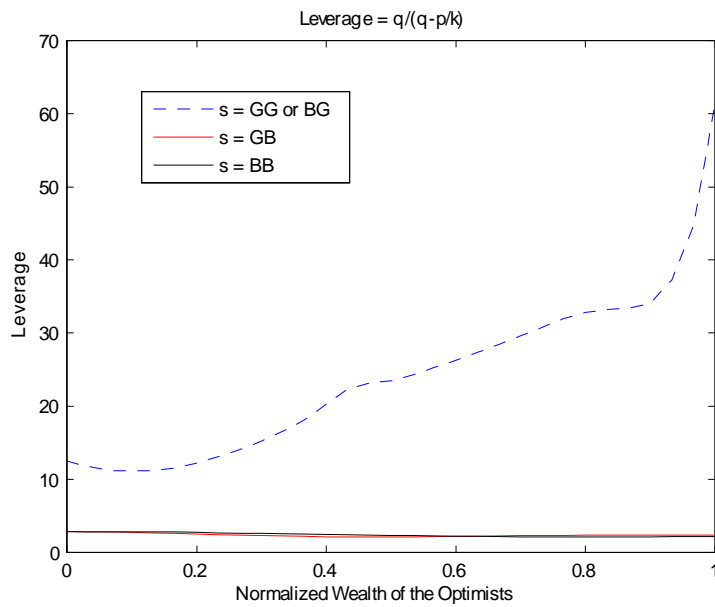

Figure 8: Leverage Cycles

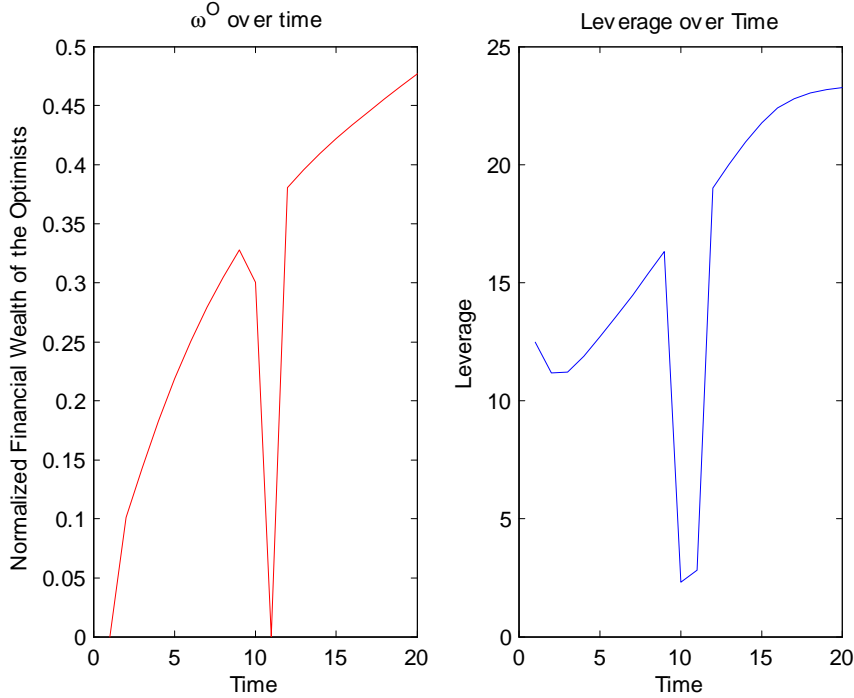

Figure 9: Leverage Cycles

important role in driving up asset price volatility. It is then tempting to conclude that by restricting leverage, we can reduce the variation of wealth of the optimists, therefore reduce asset price volatility. However, this simple intuition is not always true by two reasons. First, restricting leverage limits the demand for asset of the optimists when their "financial wealth" is small, therefore drives down asset price. In contrast, when their "financial wealth" is large, restricting leverage does not affect the demand, thus does not affect asset price. The two channels create a potential for higher asset price volatility. Second, restricting leverage does reduce asset price in the short run when the optimists are poor, however in the long run they can accumulate the asset and become wealthier. High leverage requirements prevent them from falling back to the low wealth region. So in the long run, restricting leverage drives up asset price volatility due to the first reason and high long run wealth of the optimists.

To show this statement, I go to the extreme case, when leverage is strictly forbidden, i.e., there are no financial assets. The Figure 10 plots the volatility of asset price as function of the wealth of the optimists in two cases, with financial markets and without financial markets<sup>14</sup>. We can see that, with financial markets, asset volatility is higher when the optimists are poor and lower when they are rich. The reverse holds without financial markets. The numerical solution also shows that, without financial markets, the optimists always accumulate assets to move up to the high wealth region. This dynamics makes asset price more volatile without financial markets then it is with financial markets.

Figure 11 shows the Monte-Carlo simulation for an economy starting in good state and

<sup>14</sup>Without financial market, "financial wealth" is asset holding itself.



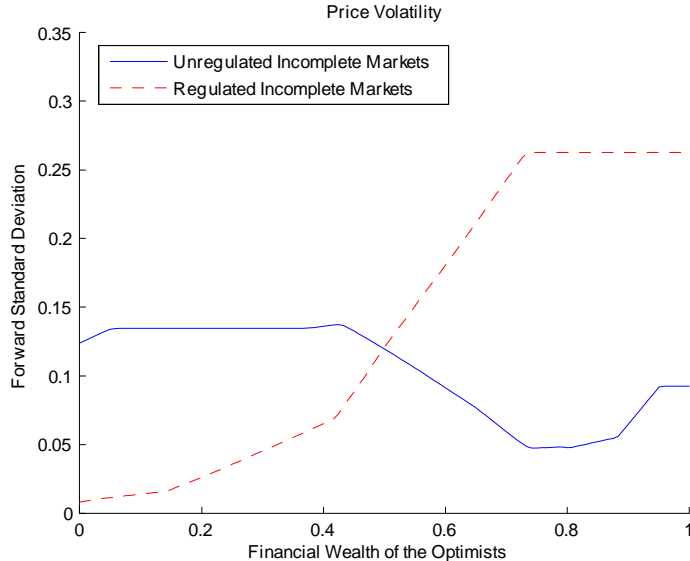

Figure 10: Asset Price Volatility in Unregulated and Regulated Economies

$\omega^O = 0$ . The figure plots the evolution of the average of the normalized financial wealth of the optimists, left panel, and asset price volatility, right panel, over time (the solid lines represent the unregulated economy and the dashed lines represent the regulated economy). As discussed above, the wealth of the optimists remains low in average in the unregulated economy but increases to a permanently high level under regulation. Thus, initially asset price volatility is higher in the unregulated economy than in the regulated economy. The reverse inequality holds, however, as over time, the wealth of the optimists increase more in the regulated economy than in the unregulated economy.

I conclude this part with two additional remarks. First, intermediate regulations can be computed using Proposition 8. If the regulator requires collateral  $k \geq k_r$ . Then the proposition shows that in equilibrium, only the leverage level  $\max(k_t^*, k_r)$  prevails. Numerical solution for intermediate regulations, confirms the conclusion in the paragraphs above. Second, regulation not only fails to reduce asset price volatility, it also reduces welfare of both types of agents as it reduces trading possibilities.

## 6 Conclusion

In this paper I develop a dynamic general equilibrium model to examine the effects of belief heterogeneity on the survival of agents and on asset price and investment volatility under different financial markets structures. I show that, when financial markets are endogenously incomplete, agents with incorrect beliefs survive in the long run. The survival of these agents leads to higher asset price and investment volatility. This result contrasts with the frictionless complete markets case, in which agents holding incorrect beliefs are eventually driven out and as a result, asset prices and investment exhibit lower volatility.

In addition, I show the existence of stationary Markov equilibria in this framework with

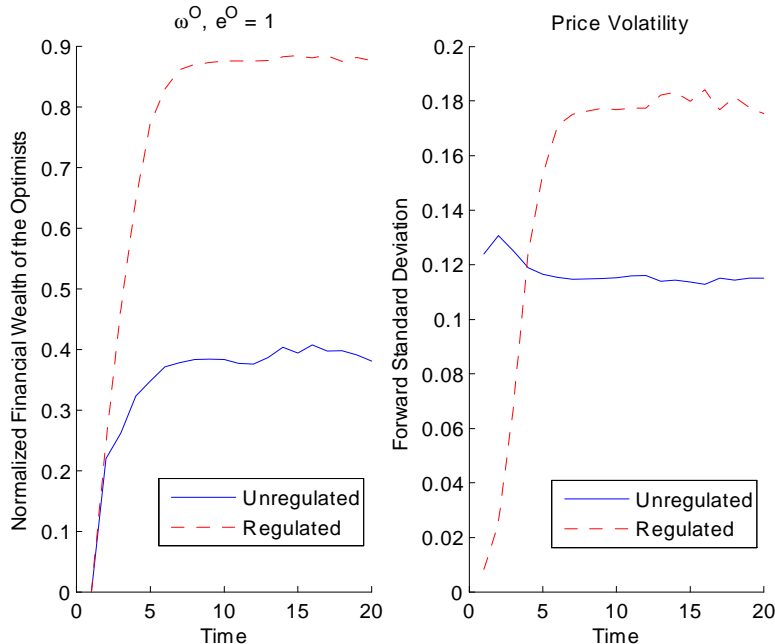

Figure 11: Wealth Distribution and Asset Price Volatility over Time

incomplete financial markets and with general production and capital accumulation technology. I also develop an algorithm for computing the equilibria. As a result, the framework can be readily used to investigate questions about the interaction between financial markets and the macroeconomy. For instance, it would be interesting in future work to apply these methods in calibration exercises using more rigorous quantitative asset pricing techniques, such as in Alvarez and Jermann (2001). This could be done by allowing for uncertainty in the growth rate of dividends rather than uncertainty in the levels, as modeled in this paper, in order to match the rate of return on stock markets and the growth rate of aggregate consumption. Such a model would provide a set of moment conditions that could be used to estimate relevant parameters using GMM as in Chien and Lustig (2009). A challenge in such work, however, is that finding the Markov equilibria is computationally demanding.

A second avenue for further research is to examine more normative questions in the framework developed in this paper. My results suggest, for example, that financial regulation aimed at reducing asset price and real investment volatility should be state-dependent, as conjectured by Geanakoplos (2009). It would also be interesting to consider the effects of other intervention policies, such as bail-out or monetary policies.

## 7 Appendix

To prove the existence of equilibrium in finite horizon, I allow utility to be dependent of labor decision. So per period utility of agent  $h$  is  $U_h(c, L_h - l) : (\mathbf{R}^+)^2 \rightarrow \mathbf{R}$  over consumption and leisure. I replace Assumption 5 by the following Assumption

**Assumption 5b:**  $U_h(c, l)$  is strictly increasing in  $c$ , non-decreasing in  $l$  and concave in  $(c, l)$ .

**Definition 4** *An allocation*

$$\begin{pmatrix} c_t^h(s^t), k_{a,t}^h(s^t), l_{a,t}^h(s^t), \phi_{j,t}^h(s^t) \\ K_{a,t}^n(s^t), K_{a,t}^o(s^t), \psi_{a,t}(s^t) \\ K_{a,t}^f(s^t), L_{a,t}(s^t), y_{a,t}(s^t) \end{pmatrix}$$

together with the no default penalty defined in (3), is attainable if consumptions, real asset holdings, labor decision from the consumers, new and old real assets decision from the real asset producers and capital and labor decisions of final good producers are positive. The resources constrained are satisfied

$$\begin{aligned} L_a^h &\geq l_{a,t}^h(s^t) \\ \psi_{a,t}(s^t) &\geq \Psi_a(K_{a,t}^n(s^t), K_{a,t}^o(s^t)) \\ F(K_{a,t}^f(s^t), L_{a,t}(s^t), s) &\geq y_{a,t}(s^t) \end{aligned}$$

$(\psi_{a,T}(s^T) \geq \Psi_a(0, K_{a,T}^o(s^T)))$  given  $K_{a,T+1}(s^T) = 0$ ) and excess demands are negative: First, excess demands on the good markets are negative:

$$\sum_{h=1}^H c_t^h + \sum_{a \in \mathcal{A}_0} \psi_{a,t} - \sum_{h=1}^H e_t^h - \sum_{a \in \mathcal{A}_1} d_{a,t} \sum_h k_{a,t-1}^h - \sum_{a \in \mathcal{A}_0} y_{a,t} - \sum_{\substack{j=1 \\ f_{j,t}=b_{j,t}}}^J \left( \sum_{h=1}^H \phi_{j,t-1}^h \right) b_{j,t} \leq 0$$

Second, for  $a \in \mathcal{A}_0$

$$\begin{aligned} \sum_{h=1}^H k_{a,t}^h - K_{a,t}^n &\leq 0 \\ K_{a,t}^o - \sum_{h=1}^H k_{a,t-1}^h - \sum_{\substack{j=1 \\ f_{j,t} < b_{j,t}}}^J \left( \sum_{h=1}^H \phi_{j,t-1}^h \right) k_{j,t-1}^a &\leq 0 \\ K_{a,t}^f - \sum_{h=1}^H k_{a,t-1}^h - \sum_{\substack{j=1 \\ f_{j,t} < b_{j,t}}}^J \left( \sum_{h=1}^H \phi_{j,t-1}^h \right) k_{j,t-1}^a &\leq 0 \\ L_{a,t} - \sum_{h=1}^H l_{a,t}^h &\leq 0 \end{aligned}$$

$$\sum_{h=1}^H \phi_{j,t}^h \leq 0. \quad (35)$$

for  $a \in \mathcal{A}_1$

$$\sum_{h=1}^H k_{a,0}^h - K_{a,-1} \leq 0.$$

in each time-state  $t, s^t$  with  $0 < t < T$ . For the initial period there is no explicit initial debt and the aggregate supply of asset  $a$  is  $K_{a,-1}$  so

$$\sum_{h=1}^H c_0^h + \sum_{a \in \mathcal{A}_0} \psi_{a,0} - \sum_{h=1}^H e_0^h - \sum_{a \in \mathcal{A}_1} d_{a,0} K_{a,-1} - \sum_{a \in \mathcal{A}_0} y_{a,0} \leq 0$$

For  $a \in \mathcal{A}_1$

$$\begin{aligned} \sum_{h=1}^H k_{a,0}^h - K_{a,-1} &\leq 0 \\ K_{a,0}^o - K_{a,-1} &\leq 0 \\ K_{a,0}^f - K_{a,-1} &\leq 0 \\ L_{a,0} - \sum_{h=1}^H l_{a,0}^h &\leq 0 \\ \sum_{h=1}^H \phi_{j,0}^h &\leq 0. \end{aligned} \quad (36)$$

For  $a \in \mathcal{A}_0$

$$\sum_{h=1}^H k_{a,0}^h - K_{a,0}^n \leq 0$$

For  $t = T$ , there is no financial assets that pay-off at  $T + 1$ , so

$$\sum_{h=1}^H c_T^h + \sum_{a \in \mathcal{A}_0} \psi_{a,T} - \sum_{h=1}^H e_T^h - \sum_{a \in \mathcal{A}_1} d_{a,T} \sum_h k_{a,t-1}^h - \sum_{a \in \mathcal{A}_0} y_{a,T} - \sum_{\substack{j=1 \\ f_{j,T}=b_{j,T}}}^J \left( \sum_{h=1}^H \phi_{j,T-1}^h \right) b_{j,T} \leq 0$$

For  $a \in \mathcal{A}_1$

$$\begin{aligned} K_{a,T}^f - \sum_{h=1}^H k_{a,T-1}^h - \sum_{\substack{j=1 \\ f_{j,T} < b_{j,T}}}^J \left( \sum_{h=1}^H \phi_{j,T-1}^h \right) k_{j,T-1}^a &\leq 0 \\ L_{a,T} - \sum_{h=1}^H l_{a,T}^h &\leq 0. \end{aligned} \quad (37)$$

For  $a \in \mathcal{A}_0$

$$K_{a,T}^o - \sum_{h=1}^H k_{a,T-1}^h - \sum_{\substack{j=1 \\ f_{j,T} < b_{j,T}}}^J \left( \sum_{h=1}^H \phi_{j,T-1}^h \right) k_{j,T-1}^a \leq 0$$

**Lemma 4** *The set of attainable allocations is bounded.*

**Proof.** We prove this Lemma by induction in  $t$ .

Before all, notice that given

$$\sum_h k_{a,t}^h - \sum_h k_{a,t-1}^h - \sum_{f_{j,t} < b_{j,t}} k_{a,t}^j \sum_h \phi_{j,t-1}^h \leq 0$$

for each  $a \in \mathcal{A}_1$ , and  $t \leq T$ , we have

$$\begin{aligned} \sum_h k_{a,t}^h &\leq \sum_h k_{a,t-1}^h + \sum_{f_{j,t} < b_{j,t}} k_{a,t}^j \sum_h \phi_{j,t-1}^h \\ &\leq \sum_h k_{a,t-1}^h \\ &\leq \dots \\ &\leq \sum_h k_{a,0}^h \leq K_{a,-1} \end{aligned}$$

**Step 1**  $t \mapsto t+1$ : Suppose there is an  $M_t$  such that for each attainable allocations associate with an economy that

$$\begin{aligned} M_t &\geq c_t^h(s^t) \geq 0 \\ M_t &\geq k_{a,t-1}^h(s^t) \geq 0 \\ M_t &\geq K_{a,t}^n(s^t) \geq 0 \\ M_t &\geq K_{a,t}^o(s^t) \geq 0 \\ M_t &\geq K_{a,t+1}^f(s^{t+1}) \geq 0 \\ M_t &\geq y_{a,t+1}(s^{t+1}) \geq 0 \\ M_t &\geq |\psi_{a,t}(s^t)| \end{aligned}$$

we show that the statement holds at  $t+1 \leq T$  by using the system of inequalities (35) and (37): For  $a \in \mathcal{A}_0$  we have

$$K_{a,t+1}^o - \sum_{h=1}^H k_{a,t}^h - \sum_{\substack{j=1 \\ f_{j,t+1} < b_{j,t+1}}}^J \left( \sum_{h=1}^H \phi_{j,t}^h \right) k_{j,t}^a \leq 0$$

and

$$\sum_{h=1}^H \phi_{j,t}^h \leq 0,$$

therefore

$$K_{a,t+1}^o \leq HM_t = M_{t+1}^o.$$

Similarly

$$K_{a,t+1}^f - \sum_{h=1}^H k_{a,t}^h - \sum_{\substack{j=1 \\ f_{j,t+1} < b_{j,t+1}}}^J \left( \sum_{h=1}^H \phi_{j,t}^h \right) k_{j,t}^a \leq 0$$

therefore

$$K_{a,t+1}^f \leq M_{t+1}^o.$$

Besides,

$$\begin{aligned} \psi_{a,t+1} &\geq \Psi_a(K_{a,t+2}^n, K_{a,t+1}^o) \\ &\geq \Psi_a(0, M_{t+1}^o) = -M_{a,t+1}^{\psi-}. \end{aligned}$$

Second

$$\sum_{h=1}^H c_{t+1}^h + \sum_{a \in \mathcal{A}_0} \psi_{a,t+1} - \sum_{h=1}^H e_{t+1}^h - \sum_{a \in \mathcal{A}_1} d_{a,t+1} \sum_h k_{a,t+1}^h - \sum_{a \in \mathcal{A}_0} y_{a,t+1} - \sum_{\substack{j=1 \\ f_{j,t+1} = b_{j,t+1}}}^J \left( \sum_{h=1}^H \phi_{j,t}^h \right) b_{j,t+1} \leq 0$$

and

$$\sum_{h=1}^H \phi_{j,t}^h \leq 0$$

implies

$$\sum_{h=1}^H c_{t+1}^h + \sum_{a \in \mathcal{A}_0} \psi_{a,t+1} \leq \sum_{h=1}^H e_{t+1}^h + \sum_{a \in \mathcal{A}_1} d_{a,t+1} K_{a,-1} + A_0 M_t.$$

Given that  $c_{t+1}^h \geq 0$ , for  $a \in \mathcal{A}_0$

$$\psi_{a,t+1} \leq \max_{s^T} \sum_{h=1}^H e_{t+1}^h + \sum_{a \in \mathcal{A}_1} d_{a,t+1} K_{a,-1} + A_0 M_t + (A_0 - 1) M_{a,t+1}^{\psi-} = M_{t+1}^{\psi}.$$

Therefore,

$$\Psi_a(K_{a,t+1}^n, K_{a,t+1}^o) \leq M_{t+1}^{\psi}$$

since

$$\Psi_a(K_{a,t+1}^n, K_{a,t+1}^o) \leq \psi_{a,t+1}.$$

Also, given

$$K_{a,t+1}^o \leq M_{t+1}^o,$$

and  $\Psi_a$  is decreasing in  $K_{a,t+1}^o$ , we have

$$\Psi_a(K_{a,t+1}^n, M_{t+1}^o) \leq M_{t+1}^{\psi}$$

so

$$K_{a,t+1}^n \leq \Psi_{a,2}^{-1}(M_{t+1}^o, M_{t+1}^{\psi}) = M_{a,t+1}^n.$$

Finally

$$\begin{aligned} \sum_{h=1}^H c_{t+1}^h &\leq \sum_{h=1}^H e_{t+1}^h + \sum_{a \in \mathcal{A}_1} d_{a,t+1} K_{a,-1} + A_0 M_t - \sum_{a \in \mathcal{A}_0} \psi_{a,t+1} \\ &\leq \sum_{h=1}^H e_{t+1}^h + \sum_{a \in \mathcal{A}_1} d_{a,t+1} K_{a,-1} + A_0 M_t + \sum_{a \in \mathcal{A}_0} M_{a,t+1}^{\psi-} = M_{t+1}^c. \end{aligned}$$

Lastly,

$$L_{a,t+2} \leq \sum_{h=1}^H L_a^h = \bar{L}_a$$

and

$$K_{a,t+2}^f \leq \sum_{h=1}^H k_{a,t+1}^h \leq K_{a,t+1}^n \leq M_{a,t+1}^n$$

therefore

$$y_{t+2} \leq \max_s F_a(M_{a,t+2}^n, \bar{L}_a, s) = M_{a,t+1}^f$$

Let

$$M_{t+1} = \max \left( M_{t+1}^c, M_{t+1}^o, M_{a,t+1}^n, M_{a,t+1}^f, M_{t+1}^\psi, M_{a,t+1}^{\psi-} \right).$$

we have

$$c_t^h, k_{a,t+2}^h, K_{a,t+1}^n, K_{a,t+1}^o, \psi_{a,t+1}, K_{a,t+2}^f, y_{a,t+2}$$

are bounded by  $M_{t+1}$ .

**Step 2**  $t = 0$  : Similarly proof using (36). ■

**Proof of Theorem 2.** In this proof, we allow non-trivial labor choice decision, by supposing utility function of each consumer is concave over consumption and leisure  $U_h(c, L - l)$ . We restrict choices of produces and consumers to  $[-2M_T, 2M_T]$ , (keeping bond holding choices in  $[-B, +B]$  and labor choices of final good producers in  $[0, 2\bar{L}_a]$ ) constructed from above. To simplify the proof, we switch from the final good as numeraire to the following normalization:

Let  $\Delta$  denote the set of prices  $(p^c, q_a^*, q_a, d_a, w_a, p_j)$  such that

$$\begin{aligned} p^c, q_a^*, q_a, d_a, w_a, p_j &\geq 0 \\ p^c + \sum_{a \in \mathcal{A}_0} q_a^* + \sum_{a \in \mathcal{A}} q + \sum_{a \in \mathcal{A}_0} d_a + \sum_{a \in \mathcal{A}_0} w_a + \sum_{j \in \mathcal{J}} p_j &= 1 \end{aligned}$$

For each state  $s^t$  we normalize prices in each time-state pair such that

$$(p^c(s^t), q_a^*(s^t), q_a(s^t), d_a(s^t), w_a(s^t), p_j(s^t)) \in \Delta.$$

for  $t \leq T - 1$  and for the final date

$$(q, p^c, d_a, w_a, p) \in \Delta^f,$$

in which

$$\Delta^f = \left\{ (p^c, q_a, d_a, w_a) \geq 0 : p^c + \sum_{a \in \mathcal{A}_0} q_a + \sum_{a \in \mathcal{A}_0} d_a + \sum_{a \in \mathcal{A}_0} w_a = 1 \right\}.$$

Notice that the no-default constraint has become

$$f_{j,t+1}(s^{t+1}) = \min \left\{ p_t^c(s^t) b_j(s_{t+1}), \sum_{a=1}^A k_a^j(s^t) (q_a(s^{t+1}) + d_a(s^{t+1})) \right\}$$

The optimal decisions of the capital producers yield  $(K_{a,t}^n, K_{a,t}^o, \psi_{a,t})_{s \in \Sigma^{T-1}}$ , final good producers yields  $(K_{a,t}^f, L_{a,t}, y_{a,t})_{s \in \Sigma^T}$  and the decision of the consumer yields

$$(c_t^h, l_{a,t}^h, k_{a,t+1}^h, \phi_{j,t+1}^h)_{s \in \Sigma^{T-1}} \times (c_t^h, l_{a,t}^h)_{s \in \Sigma^T \setminus \Sigma^{T-1}}.$$

Let  $Z$  denote the correspondence that maps each set of prices

$$(p_t^c, q_t^*, q_t, d_t, w_t, p_{j,t})_{s \in \Sigma^{T-1}} \times (q, p_t^c, d_t, w_t)_{s \in \Sigma^T \setminus \Sigma^{T-1}}$$

to the excess demand in each market in each time-state pair

$$\begin{aligned} Z : \Delta \|\Sigma^{T-1}\| \times (\Delta^f)^{\|\Sigma^T \setminus \Sigma^{T-1}\|} &\rightrightarrows \mathbf{R}^{(1+A_1+4A_0+J)\|\Sigma^{T-1}\|+(1+3A_0)\|\Sigma^T \setminus \Sigma^{T-1}\|} \\ p \in \Delta \|\Sigma^{T-1}\| \times (\Delta^f)^{\|\Sigma^T \setminus \Sigma^{T-1}\|} &\longmapsto z = (\text{excess demands}) \end{aligned} \quad (38)$$

The component of the excess demand in each market corresponds to the component of the price system in that market. When  $\sigma \in \|\Sigma^{T-1}\|$  there is one market for final good,  $A_1$  markets for assets with fixed supply and  $4A_0$  markets corresponding to new units, old units for asset production, old units for production and labor market for each asset with elastic supply, and finally  $J$  market for financial securities. When  $\sigma \in \|\Sigma^T\|$  there are no market for financial securities nor new units of assets.

In Lemma 6, we establish that  $Z$  is upper hemi-continuous and compact, convex-valued. Given each individual choice is bounded,  $Z$  is bounded for example by a closed cube  $K$  of  $\mathbf{R}^{(1+A_1+4A_0+J)\|\Sigma^{T-1}\|+(1+3A_0)\|\Sigma^T \setminus \Sigma^{T-1}\|}$ . Consider the following correspondence

$$\begin{aligned} F : \left( \Delta \|\Sigma^{T-1}\| \times (\Delta^f)^{\|\Sigma^T \setminus \Sigma^{T-1}\|} \right) \times K &\rightrightarrows \left( \Delta \|\Sigma^{T-1}\| \times (\Delta^f)^{\|\Sigma^T \setminus \Sigma^{T-1}\|} \right) \times K \\ &\longmapsto \arg \max_{\tilde{p} \in \left( \Delta \|\Sigma^{T-1}\| \times (\Delta^f)^{\|\Sigma^T \setminus \Sigma^{T-1}\|} \right)} \{ \tilde{p} \cdot z \} \times Z(p). \end{aligned}$$

Since  $F$  is an upper hemi-continuous correspondence, with non-empty, compact convex value. Kakutani's theorem guarantees that  $F$  has a fixed point

$$\bar{p} = \left( (\bar{p}_t^c, \bar{q}_{a,t}^*, \bar{q}_{a,t}, \bar{d}_{a,t}, \bar{w}_{a,t}, \bar{p}_{j,t})_{s \in \Sigma^{T-1}} \times (\bar{p}_T^c, \bar{q}_{a,T}, \bar{d}_{a,T}, \bar{w}_{a,T})_{s \in \Sigma^T \setminus \Sigma^{T-1}}, \bar{z} \right).$$



We simplify the notations by denoting

$$\begin{aligned}\bar{p}_t(s^t) &= (\bar{p}_t^c, \bar{q}_{a,t}^*, \bar{q}_{a,t}, \bar{d}_{a,t}, \bar{w}_{a,t}, \bar{p}_{j,t}) \text{ for } s^t \in \Sigma^{T-1} \\ \bar{p}_T(s^T) &= (\bar{p}_T^c, \bar{q}_{a,T}, \bar{d}_{a,T}, \bar{w}_{a,T}) \text{ for } s^T \in \Sigma^T \setminus \Sigma^{T-1}\end{aligned}$$

Notice that, by summing up over consumers' budget constraint as done in Lemma 5 we obtain the following inequalities

$$\begin{aligned}p_t^c Z_t^c(s^t) + \sum_{a \in \mathcal{A}_1} q_{a,t} Z_{a,t}^{K^o}(s^t) + \sum_{j=1}^J p_{j,t} Z_{j,t}(s^t) + \sum_{a \in \mathcal{A}_0} q_t^* Z_{a,t}^{K^n}(s^t) + \sum_{a \in \mathcal{A}_0} q_{a,t} Z_{a,t}^K(s^t) \\ + \sum_{a \in \mathcal{A}_0} d_{a,t} Z_{a,t}^{K^f}(s^t) + \sum_{a \in \mathcal{A}_0} w_{a,t} Z_{a,t}^L(s^t) \leq 0\end{aligned}\quad (39)$$

for each  $t \leq T-1$ . Notice that for  $t=0$   $\sum_{h=1}^H \phi_{j,-1}^h = 0$  and  $\sum_{h=1}^H k_{a,-1}^h = K_{a,-1}$ . For the notations used above, we have

$$Z_t^c(s^t) = \sum_{h=1}^H c_t^h + \sum_{a \in \mathcal{A}_0} \psi_{a,t} - \sum_{h=1}^H e_t^h - \sum_{a \in \mathcal{A}_1} d_{a,t} \sum_h k_{a,t-1}^h - \sum_{a \in \mathcal{A}_0} y_{a,t} - \sum_{\substack{j=1 \\ f_{j,t} = p_t^c b_{j,t}}}^J \left( \sum_{h=1}^H \phi_{j,t-1}^h \right) b_{j,t}$$

$$Z_{a,t}^{K^n}(s^t) = \sum_{h=1}^H k_{a,t}^h - K_{a,t}^n$$

$$Z_{a,t}^{K^o}(s^t) = K_{a,t}^o - \sum_{h=1}^H k_{a,t-1}^h - \sum_{\substack{j=1 \\ f_{j,t} < b_{j,t}}}^J \left( \sum_{h=1}^H \phi_{j,t-1}^h \right) k_{j,t}^a$$

$$Z_{a,t}^{K^f}(s^t) = K_{a,t}^f - \sum_{h=1}^H k_{a,t-1}^h - \sum_{\substack{j=1 \\ f_{j,t} < b_{j,t}}}^J \left( \sum_{h=1}^H \phi_{j,t-1}^h \right) k_{j,t}^a$$

$$Z_{a,t}^L(s^t) = L_{a,t} - \sum_{h=1}^H l_{a,t}^h$$

For  $a \in \mathcal{A}_0$

$$Z_{a,t}^K(s^t) = \sum_h k_{a,t}^h - \sum_h k_{a,t-1}^h - \sum_{\substack{j=1 \\ f_{j,t} < p_t^c b_{j,t}}} k_{a,t}^j \sum_h \phi_{j,t-1}^h$$

and for  $j \in \mathcal{J}_t$

$$Z_{j,t}(s^t) = \sum_h \phi_{j,t}^h$$

For  $t = T$

$$p_T^c Z_T^c(s^T) + \sum_{a \in \mathcal{A}_0} q_{a,T} Z_T^{K^o}(s^T) + \sum_{a \in \mathcal{A}_0} d_{a,T} Z_T^{K^f}(s^T) + \sum_{a \in \mathcal{A}_0} w_{a,T} Z_T^L(s^T) \leq 0 \quad (40)$$

with

$$\begin{aligned}
Z_T^c(s^T) &= \sum_{h=1}^H c_T^h + \sum_{a \in \mathcal{A}_0} \psi_{a,T} - \sum_{h=1}^H e_T^h - \sum_{a \in \mathcal{A}_1} d_{a,T} \sum_h k_{a,T-1}^h - \sum_{a \in \mathcal{A}_0} y_{a,T} - \sum_{\substack{j=1 \\ f_{j,T} = p_T^c}}^J \left( \sum_{h=1}^H \phi_{j,T-1}^h \right) b_{j,T} \\
Z_{a,T}^{K^o}(s^T) &= K_{a,T}^o - \sum_{h=1}^H k_{a,T}^h - \sum_{\substack{j=1 \\ f_{j,T} < b_{j,T}}}^J \left( \sum_{h=1}^H \phi_{j,T-1}^h \right) k_{j,T}^a \\
Z_{a,T}^{K^f}(s^T) &= K_{a,T}^f - \sum_{h=1}^H k_{a,T}^h - \sum_{\substack{j=1 \\ f_{j,T} < b_{j,T}}}^J \left( \sum_{h=1}^H \phi_{j,T-1}^h \right) k_{j,T}^a \\
Z_{a,T}^L(s^T) &= L_{a,T} - \sum_{h=1}^H l_{a,T}^h
\end{aligned}$$

We re-write these inequalities compactly as

$$\bar{p}_t(s^t) \cdot \bar{z}_t(s^t) \leq 0 \quad \forall t = 0, s^t.$$

Given

$$\bar{p}_t \in \arg \max_{\tilde{p} \in \Delta} \{\tilde{p} \cdot \bar{z}_t\}$$

we have (by choosing  $\tilde{p}$  in the corner of  $\Delta$  or  $\Delta_f$  depending on whether  $t < T$ )  $\bar{z}_t \leq 0$  for each time-state pair  $t, s^t$ . In Lemma 4, the choices are bounded by  $M_T$  therefore the artificial bound  $2M_T$  is not binding. Now we can show that prices are strictly positive:

- 1)  $\bar{p}_t^c > 0$  otherwise  $\bar{c}_t^h$  will reach the artificial bound  $2M_T$ , which contradicts the fact that the bound is not binding. Similarly
- 2) Given  $\bar{p}_t^c > 0, \bar{d}_{a,t} > 0$  otherwise  $\bar{K}_{a,t}^f$  will reach the artificial bound.
- 3) Given  $\bar{d}_{a,t+1} > 0, \bar{q}_{a,t}^* > 0$  otherwise  $\bar{k}_{a,t}^h$  will reach the artificial bound.
- 4) Given  $\bar{p}_t^c > 0, \bar{q}_{a,t} > 0$  otherwise  $\bar{K}_{a,t}^o$  will reach the artificial bound.
- 5) If  $\bar{w}_{a,t} = 0$  then  $\bar{L}_t = 2\bar{L}_a, \bar{l}_{a,t}^h \leq L_a^h$  which contradicts the negative excess demand in the labor markets, so  $\bar{w}_{a,t} > 0$ .
- 6) Finally if  $\bar{p}_{j,t}^b = 0$  then  $\bar{\phi}_{j,t+1}^h = B$  because  $f_{j,t+1} > 0$ , therefore  $\sum_h \bar{\phi}_{j,t+1}^h = HB > 0$ , which contradicts the negative excess demand in the financial market for asset  $j$ .

Therefore, we must have

$$\bar{p}_t^c, \bar{q}_{a,t}^*, \bar{q}_{a,t}, \bar{d}_{a,t}, \bar{w}_{a,t}, \bar{p}_{j,t}^b > 0.$$

$\bar{p}_t^c > 0$  also implies budget constraints, and therefore (39) and (40) hold with equality, so markets must clear. The collateral constraints (8) implies that if  $\phi_{j,t} < 0$  then  $-\phi_{j,t} < \frac{M_T}{k_{j,a}}$ , where  $k_{j,a} = \min_{s \in \mathcal{S}} k_{j,a}(s) > \underline{k}$ . Therefore if  $\phi_{j,t}^h > 0; \phi_{j,t}^h < (H-1) \frac{M_T}{k_{j,a}}$ . We can choose  $M_T$  independent of  $B$ , so we can choose  $B$  such that  $B = (H-1) \frac{M_T}{k_{j,a}}$ ; this artificial constraint will not be binding. To conclude, observing that in this fixed point, all the artificial bounds are slack: we have thus found an equilibrium. ■

**Lemma 5 (Walras' Law)** *Given that consumers, firms optimize subject to their constraints, we obtain inequalities (39) and (40).*

**Proof.** We sum up the budget constraints (7) across all consumers

$$\begin{aligned}
& \sum_h p_t^c c_t^h + \sum_h \sum_{a \in \mathcal{A}_1} q_{a,t} k_{a,t}^h + \sum_h \sum_{a \in \mathcal{A}_0} q_{a,t}^* k_{a,t}^h + \sum_h \sum_{j=1}^J p_{j,t} \phi_{j,t}^h \\
& \leq \sum_h p_t^c e_t^h + \sum_h \sum_{a \in \mathcal{A}_0} w_{a,t} l_{a,t}^h + \sum_h \sum_{j=1}^J f_{j,t} \phi_{j,t-1}^h \\
& \quad + \sum_h \sum_{a \in \mathcal{A}_0} (q_{a,t} + d_{a,t}) k_{a,t-1}^h + \sum_h \sum_{a \in \mathcal{A}_1} (q_{a,t} + d_{a,t}) k_{a,t-1}^h \\
& \quad + \sum_a \Pi_t^f + \sum_a \Pi_t^a
\end{aligned}$$

So, moving endowment in final good  $e_t^h$  from the right hand side to the left hand side we obtain

$$\begin{aligned}
& p_t^c \left( \sum_h c_t^h - \sum_h e_t^h \right) + \sum_{a \in \mathcal{A}_1} q_{a,t} \left( \sum_h k_{a,t}^h \right) \\
& \quad + \sum_{a \in \mathcal{A}_0} q_{a,t}^* \left( \sum_h k_{a,t}^h \right) + \sum_{j=1}^J p_{j,t} \left( \sum_h \phi_{j,t}^h \right) \\
& \leq \sum_h \sum_{a \in \mathcal{A}_0} w_{a,t} l_{a,t}^h + \sum_h \sum_{j=1}^J f_{j,t} \phi_{j,t-1}^h \\
& \quad + \sum_h \sum_{a \in \mathcal{A}_0} (q_{a,t} + d_{a,t}) k_{a,t-1}^h + \sum_h \sum_{a \in \mathcal{A}_1} (q_{a,t} + p_t^c d_{a,t}) k_{a,t-1}^h \\
& \quad + \sum_{a \in \mathcal{A}_0} \Pi_{a,t}^f + \sum_{a \in \mathcal{A}_0} \Pi_{a,t}
\end{aligned} \tag{41}$$

Notice that

$$\Pi_{a,t}^f = p_t^c y_{a,t} - d_{a,t} K_{a,t}^f - w_{a,t} L_{a,t}$$

and

$$\Pi_{a,t} = q_{a,t}^* K_{a,t}^n - p_t^c \psi_{a,t} - q_{a,t} K_{a,t}^o.$$

and if  $f_{j,t} < p_t^c b_{j,t}$

$$f_{j,t} = \sum_{a=1}^A k_{a,t}^j (q_{a,t} + d_{a,t}).$$

Plugging these equalities into, (41) we obtain exactly the inequality(39). The inequality (40) is obtained similarly. ■

**Lemma 6** *Z defined in (38) is upper hemi-continuous and compact, convex-valued.*

**Proof.** These properties are standard. ■

**Proof of Lemma 3.** Given any equilibrium, let  $\mu_{a,t}$  denote the Lagrange multipliers associated to the collateral constraints, (8) in the consumers' optimization problem. First we show that consumptions are bounded from above and below: Market clearing condition implies  $c_t^h \leq \bar{e}$ . Second for each  $t$  one of the feasible strategies is to consume at least the endowment in each period therefore

$$\sum_{t'=t}^T \mathbf{P}_h \left( s^{t'} | s^t \right) \beta_h^{t'-t} U_h \left( c_t^h \right) \geq \sum_{t'=t}^T \mathbf{P}_h \left( s^{t'} | s^t \right) \beta_h^{t'-t} U_h \left( e_h \left( s^{t'} \right) \right)$$

Therefore

$$U_h \left( c_t^h \right) + \max \left\{ \frac{\beta_h}{1 - \beta_h} U_h \left( \bar{e} \right), 0 \right\} \geq \min \left\{ \min_{s \in \mathcal{S}} \frac{1}{1 - \beta_h} U_h \left( e^h \left( s \right) \right), \min_{s \in \mathcal{S}} U_h \left( e^h \left( s \right) \right) \right\}$$

so

$$c_t^h \geq \underline{c}.$$

Second, we prove by induction that for each  $a \in \mathcal{A}_0$ ,  $K_{a,t+1} \leq \bar{K}_a$ . Indeed, good market at time  $t$  clears implies

$$\Psi_a \left( K_{a,t+1}, K_{a,t}^o \right) \leq \bar{e}_a \left( s \right) \leq \Psi_a \left( \bar{K}_a, \bar{K}_a \right)$$

given

$$K_{a,t}^o = K_{a,t} \leq \bar{K}_a$$

and  $\Psi_a$  is decreasing in the second parameter, we have

$$\Psi_a \left( K_{a,t+1}, K_{a,t}^o \right) \geq \Psi_a \left( K_{a,t+1}, \bar{K}_a \right).$$

Therefore

$$\Psi_a \left( K_{a,t+1}, \bar{K}_a \right) \leq \Psi_a \left( \bar{K}_a, \bar{K}_a \right).$$

Since  $\Psi_a$  is increasing in the first parameters, we have

$$K_{a,t+1} \leq \bar{K}_a.$$

Now, the first-order condition of the asset producers implies

$$q_{a,t}^* = \frac{\partial \Psi_a \left( K_{a,t+1}, K_{a,t}^o \right)}{\partial K_{a,t+1}}.$$

Therefore

$$\underline{q}_a^* = \inf_{0 \leq K, K^o \leq \bar{K}_a} \frac{\partial \Psi_a \left( K, K^o \right)}{\partial K} \leq q_{a,t}^* \leq \sup_{0 \leq K, K^o \leq \bar{K}_a} \frac{\partial \Psi_a \left( K, K^o \right)}{\partial K} = \bar{q}_a^*.$$

Similarly

$$\underline{q}_a = \inf_{0 \leq K, K^o \leq \bar{K}_a} - \frac{\partial \Psi_a \left( K, K^o \right)}{\partial K^o} \leq q_{a,t} \leq \sup_{0 \leq K, K^o \leq \bar{K}_a} - \frac{\partial \Psi_a \left( K, K^o \right)}{\partial K^o} = \bar{q}_a.$$

The first-order condition with respect to  $k_{t+1}^h$  implies

$$\mu_{a,t}^h - q_{a,t}^* U_h'(c_t^h) + \beta_h E_t^h [(q_{a,t+1} + d_{a,t+1}) U_h'(c_{t+1}^h)] = 0$$

therefore

$$\begin{aligned} \bar{q}^* U_h'(c_t^h) &\geq \beta_h E_t^h [(q_{t+1} + d_{a,t+1}) U_h'(c_{t+1}^h)] \\ &> \beta_h E_t^h [d_{a,t+1} U_h'(c_{t+1}^h)] \end{aligned}$$

so  $d_{a,t+1}$  is bounded by

$$\frac{\bar{q}^* U_h'(\bar{e})}{\beta_h \text{Pr}_h(s_{t+1}|s^t) U_h'(\underline{c})} = \bar{d}_a.$$

Given

$$d_{a,t+1} = F_{a,K}(K_{a,t+1}, L_a)$$

$K_{a,t+1}$  is bounded from below by  $\underline{K}_a > 0$ . Also  $d_{a,t+1} = F_{a,K}(K_{a,t+1}, L_a) > F_{a,K}(\bar{K}_a, L_a) = \underline{d}_a$ . Similarly we have bounds  $\bar{w}$  and  $\underline{w}$  for  $w_{a,t+1}$ .

For  $a \in \mathcal{A}_1$

$$q_{a,t} \leq \frac{H}{K_{a,-1}} \bar{c} = \bar{q}_a$$

otherwise there will be a consumer that holds at least  $\frac{K_{a,-1}}{H}$  units of asset  $a$  at  $s^t$  after paying-off her debt. This consumer can sell part of her holding to pay-off debt and consume the rest of the sale. This strategy would give her more expected utility than her current one. This contradicts the optimality of her current choice. More formally, given

$$\sum_h \left( k_{a,t-1}^h + \sum_j \phi_{j,t-1}^h k_{a,t-2}^j \right) = K_{a,-1},$$

there must exist a consumer  $h$  such that

$$k_{a,t-1}^h + \sum_j \phi_{j,t-1}^h k_{a,t-2}^j \geq \frac{K_{a,-1}}{H}.$$

Therefore her budget at the beginning of period  $t$  will exceed

$$\begin{aligned} &e_t^h + \sum_{a \in \mathcal{A}_0} w_{a,t} l_{a,t}^h + \sum_{j=1}^J f_{j,t} \phi_{j,t-1}^h + \sum_{a \in \mathcal{A}} (q_{a,t} + d_{a,t}) k_{a,t-1}^h \\ &\geq (q_{a,t} + d_{a,t}) \left( k_{a,t-1}^h + \sum_j \phi_{j,t-1}^h k_{a,t-2}^j \right) \\ &\geq (q_{a,t} + d_{a,t}) \frac{K_{a,-1}}{H} \\ &> \bar{c}. \end{aligned}$$

To continue, the first-order condition

$$\mu_{a,t}^h - q_{a,t} U_h'(c_t^h) + \beta_h E_t^h [(q_{a,t+1} + d_{a,t+1}) U_h'(c_{t+1}^h)] = 0$$

yields

$$q_{a,t} \geq \max_h \frac{\beta_h \min_{s \in \mathcal{S}} d_a(s) U'_h(\bar{e})}{U'_h(\underline{c})} = \underline{q}_a.$$

The first-order condition with respect to  $\phi_{j,t+1}$  implies for an agent  $h$  with  $\phi_{j,t+1}^h \geq 0$  (check the deviation  $\phi_{j,t+1}^h + \delta\phi$ )

$$-p_{j,t} U'_h(c_t^h) + \beta_h E_h [f_{j,t+1} U'_h(c_{t+1}^h)] \leq 0.$$

So

$$\begin{aligned} p_{j,t} &\geq \frac{\beta_h E_h [f_{j,t+1} U'_h(c_{t+1}^h)]}{U'_h(c_t^h)} \\ &\geq \frac{\beta_h \min(b_j, \underline{k}(\underline{q} + \underline{d})) U'_h(\bar{e})}{U'_h(\underline{c})} = \underline{p}_j. \end{aligned}$$

Moreover we should have

$$\begin{aligned} p_{j,t} &\leq \sum_{a \in \mathcal{A}_0} \bar{q}_a^* k_a^j + \sum_{a \in \mathcal{A}_1} \bar{q}_a k_a^j \\ &\leq \left( \sum_{a \in \mathcal{A}_0} \bar{q}_a^* + \sum_{a \in \mathcal{A}_1} \bar{q}_a \right) \bar{k} = \bar{p}_j, \end{aligned}$$

otherwise it is more than enough to simultaneously buy assets and sell security  $j$ , the aggregate demand of  $\phi_j$  will be strictly negative. Also because of the market clearing condition we have  $0 \leq k_{a,t+1}^h \leq \bar{K}_a$ . Because of the collateral constraint

$$\begin{aligned} \phi_{j,t}^h &\geq \max_a \left( -\frac{\bar{K}_a}{k_{a,t}^j} \right) \\ &\geq \max_a \left( -\frac{\bar{K}_a}{\underline{k}} \right) = \underline{\phi}_j \end{aligned}$$

therefore

$$\phi_{j,t}^h \leq -(H-1) \underline{\phi}_j = \bar{\phi}_j.$$

■

**Proof of Theorem 2.** Let the compact set  $\mathcal{T} \subset \widehat{\mathcal{V}}$  denote the set over which the equilibrium endogenous variables of the finite horizon economies lie and  $E$  is defined such that the set of equilibrium total units of assets always lie in  $E$  as well. For each correspondence  $V : \mathcal{S} \times \Omega \times E \rightrightarrows \mathcal{T}$  define an operator that maps the correspondence to a new correspondence  $W : \mathcal{S} \times \Omega \times E \rightrightarrows \widehat{\mathcal{V}}$  such that

$$W(s, \omega, K) = \left\{ \begin{array}{l} \widehat{v} \in \mathcal{T} \text{ such that } (s, \omega, K, v) \in \mathcal{X} : \exists (v_s)_{s \in \mathcal{S}} \in g(s, \omega, K, v) \\ \text{such that } \forall s' \widehat{v}_{s'} \in V(s', \omega') \text{ in which } v_{s'} = (\omega', K', \widehat{v}_{s'}) \end{array} \right\}$$

Let  $V^0 = \mathcal{T}$  and  $V^{n+1} = G_{\mathcal{T}}(V^n)$ . In Lemma 7 below, we show that  $V^{n+1}$  is a non-empty correspondence for all  $n \geq 0$ . We have  $W(s, \omega, K)$  is not empty and  $W(s, \omega, K) \subset V^0 = \mathcal{T}$ . It is also easy to show that

$$V(s, \omega, K) \subset V'(s, \omega, K)$$

for all  $(s, \omega, K) \in \mathcal{S} \times \Omega \times E$  (denote  $V \subset V'$ ) then the same inclusion holds for  $W$  and  $W'$ . By definition  $V^1 \subset V^0$  so by induction we can show  $V^{n+1} \subset V^n$ . Therefore we have obtained a sequence of decreasing compact sets. Let

$$V^*(s, \omega, K) = \bigcap_{n=1}^{\infty} V^n(s, \omega, K)$$

Then  $V^*$  is a non-empty correspondence and  $G_{\mathcal{T}}(V^*) \subset V^*$ . Since graph of  $g$  is closed, we have that  $G_{\mathcal{T}}(V^*)$  is non-empty as well. Let  $V^*$  be the 'policy correspondence' and

$$F^*(s, \omega, K, v) = \left\{ \begin{array}{l} (v_s)_{s \in \mathcal{S}} \in g(s, \omega, K, v) \text{ such that} \\ \forall s' \widehat{v}_{s'} \in V^*(s', \omega') \text{ where } v_{s'} = (\omega', K', \widehat{v}_{s'}) \end{array} \right\}.$$

Then  $(V^*, F^*)$  is a Markov equilibrium. ■

**Lemma 7**  $V^{n+1}$  is a non-empty correspondence for all  $n \geq 0$ .

**Proof.** For each  $n$  let consider the equilibrium constructed in Lemma 2 for the initial condition  $(s, \omega, K)$  it is easy to show that the resulting allocation at time 0 belong to  $V^n(s, \omega, K)$ . For example, for  $n = 0$ : We use the equilibrium constructed in For each  $s_1 \in \mathcal{S}$  Let  $v_{s_1}$  is defined by

$$\begin{aligned} q_a^* &= 0 \\ p_j &= 0 \end{aligned}$$

and  $q_a, w_a, d_a$  are defined as in that construction. We also add  $k_a^h = 0, K_a = 0$  and  $\phi_j^h = 0$  the other allocations are defined in the construction as well. Then  $(s_1, v_{s_1}) \in \mathcal{X}$ . It easy to see that  $(v_s)_{s \in \mathcal{S}} \in g(s, \omega, K, v)$ . Also  $\widehat{v}_{s_1} \in V(s_1, \omega_1)$  by definition.

■

**Algorithm to Compute Competitive Equilibria:** The state space should be

$$((c_h)_{h \in \mathcal{H}}, (K_a)_{a \in \mathcal{A}_0}).$$

We find the mapping  $\rho$  from that state space into the set of current prices and investment levels  $\{q_a, q_a^*, w_a, d_a, K_a^n\}_{a \in \mathcal{A}_0}, \{q_a\}_{a \in \mathcal{A}_1}$ , future consumptions  $\left\{ (c_h^+)_{h \in \mathcal{H}} \right\}_{s \in \mathcal{S}}$ , and  $\{p_s\}_{s \in \mathcal{S}}$  the Arrow-Debreu state prices. There are therefore  $5A_0 + A_1 + SH + S$  unknowns.

First, notice that  $l_{h,a} = L_a^h$ .

For each  $a \in \mathcal{A}_0$ , from the first order condition for the asset producers and final good producers, we obtain.

$$\begin{aligned} q_a^* &= \frac{\partial \Psi_a(K_a^n, K_a)}{\partial K_a^n} \\ q_a &= -\frac{\partial \Psi_a(K_a^n, K_a)}{\partial K_a} \\ d_a &= F_K \left( K_a, \sum_a l_a^h, s \right) \\ w_a &= F_L \left( K_a, \sum_a l_a^h, s \right) \end{aligned}$$

which give  $4A_0$  equations. From the non-arbitrage equations, it should be that

$$q_a^* = \sum_s p_s (q_a^+ + d_a^+)$$

this gives another  $A_0$  equations.

For each  $a \in \mathcal{A}_1$  we also have  $A_1$  equations

$$q_a = \sum_s p_s (q_a^+ + d_a^+)$$

Regarding  $p_s$ , the inter-temporal Euler equation implies

$$p_s = \frac{U'_h(c_h^+)}{U'_h(c_h)}$$

that give  $SH$  equations and finally

$$\sum_h c_h^+ + \sum_a \Psi_a(K_a^{n+}, K_a^n) = \sum_h e_h + \sum_{a \in \mathcal{A}_0} F \left( K_a^n, \sum_a l_a^h \right) + \sum_{a \in \mathcal{A}_1} e_a K_{a,-1}$$

which give another  $S$  equations. With these  $5A_0 + A_1 + SH + S$  equations, we can solve for the  $5A_0 + A_1 + SH + S$  unknowns. That solution determines the mapping  $T\rho$ .

In order to find an equilibrium corresponding to an initial asset holdings  $(\theta_{h,a})_{h \in \mathcal{H}, a \in \mathcal{A}}$  we find the value of stream of consumption and endowment of each consumers

$$V_c^h = c_h + \sum_{s \in \mathcal{S}} p_s V_c^{h+}(s)$$

and

$$V_e^h = e_h + \sum_{s \in \mathcal{S}} p_s V_e^{h+}(s)$$

Then we solve for  $H$  unknowns  $(c_h)_{h \in \mathcal{H}}$  using  $H$  equations

$$V_c^h = V_e^h + \sum_{a \in \mathcal{A}} \theta_{h,a} q_a.$$



**Remark 1** When there are no assets with elastic supply, calculation is easier: The state space should be  $((c_h)_{h \in \mathcal{H}-1})$  We find the mapping  $\rho$  from that state space into  $\left\{ (c_h^+)_{h \in \mathcal{H}-1} \right\}_{s \in \mathcal{S}}$  future consumptions and  $\{p_s\}_{s \in \mathcal{S}}$  the Arrow-Debreu state prices. In total we have  $HS$  unknowns. Notice that we need to keep track of the consumption of only  $H-1$  consumers. The consumption of the remaining consumer is determined by the market clearing condition

$$c_H(s) = e_a(s) - \sum_{h=1}^{H-1} c_h(s).$$

he intertemporal Euler equation implies

$$p_s = \frac{U'_h(c_h^+)}{U'_h(c_h)}$$

that give  $HS$  equations. From these  $HS$  equations we can solve for the  $HS$  unknowns. When we have CRRA utility function, we can solve for closed form solution of  $p_s$  and  $c_h^+$  as presented in the following part of this Appendix.

**Algorithm to Compute Complete Markets Equilibria:** We look for the equilibrium mapping defined in (28), for each iteration, given  $\rho^n$ ,

$$\rho_s^{n+1}(\omega, K_a) = (\widehat{v}_{n+1}, \omega_{s,n+1}^+, \mu_{n+1}, \eta_{n+1})$$

is determined to satisfied the following equations

$$\begin{aligned} 0 &= \mu_{a,n+1}^h - q_{a,n+1}^* U'_h(c_{n+1}^h) \\ &\quad + \beta_h E^h \{ (q_a^+ + d_a^+) U'_h(c^{h+}) \} \\ 0 &= \mu_{a,n+1}^h \left( k_{a,n+1}^h + \sum_{j \in \mathcal{J}: \phi_j^h < 0} k_{a,j}^j \phi_{j,n+1}^h \right) \\ 0 &\leq k_{a,n+1}^h + \sum_{j \in \mathcal{J}: \phi_j^h < 0} k_a^j \phi_{j,n+1}^h. \end{aligned}$$

The variables with superscript  $+, q_a^+, d_a^+, c^{h+}, l^{h+}$  are determined using the mapping  $\rho^n$  on the state variables  $(s, \omega_s^+, K_{a,n+1})$  where

$$K_{a,n+1} = \begin{cases} \sum_{h \in \mathcal{H}} k_{a,n+1}^h & \text{if } a \in \mathcal{A}_0 \\ K_{a,-1} & \text{if } a \notin \mathcal{A}_0 \end{cases}$$

We also require

$$\begin{aligned} 0 &= \sum_{a \in \mathcal{A}} \mu_{a,n+1}^h k_a^j - p_{j,n+1} U'_h(c_{n+1}^h) \\ &\quad + \beta^h E^h \{ f_j^+ U'_h(c^{h+}) \} - \eta_{j,n+1}^h (-) \\ 0 &= -p_{j,n+1} U'_h(c_{n+1}^h) + \beta^h E^h \{ f_j^+ U'_h(c^{h+}) \} + \eta_{j,n+1}^h (-) \\ 0 &= \phi_{j,n+1}^h (+) \eta_{j,n+1}^h (+) \\ 0 &= \phi_{j,n+1}^h (-) \eta_{j,n+1}^h (-). \end{aligned}$$

The budget constraints of the consumers hold with equality

$$c_{n+1}^h = e^h(s) + \omega^h(q_{n+1} + d_{n+1}) \cdot K - q_{n+1}^* \cdot k_{n+1}^h + w_{n+1} \cdot l_{n+1}^h - p_{n+1} \cdot \phi_{n+1}^h$$

where, for each  $a \in \mathcal{A}_0$

$$\begin{aligned} q_{a,n+1}^* &= \frac{\partial \Psi_a(K_{a,n+1}, K_a^o)}{\partial K} \\ q_{a,n+1} &= -\frac{\partial \Psi_a(K_{a,n+1}, K_a^o)}{\partial K^o} \\ d_{a,n+1} &= \frac{\partial F_a(K_a^o, L_{a,n+1})}{\partial K^o} \\ w_{a,n+1} &= \frac{\partial F_a(K_a^o, L_{a,n+1})}{\partial L} \end{aligned}$$

with  $l_{a,n+1}^h = L_{h,a}$  and  $L_{a,n+1} = \sum_{h \in \mathcal{H}} l_{a,n+1}^h$ . Finally, the future wealth distributions are consistent with current asset holdings and future prices

$$\omega_s^{h+} = \frac{k_{n+1}^h \cdot (q_s^+ + d_s^+) + \sum_{j \in \mathcal{J}} \phi_{j,n+1}^h \min \{b_j(s), \sum_{a \in \mathcal{A}} k_{a,n+1}^j (q^+ + d^+)\}}{\sum_a (q^+ + d^+) \cdot K_{n+1}}$$

again the variables with superscript  $+$ ,  $q_s^+$ ,  $d_s^+$ , are determined using the mapping  $\rho^n$ .

**Proof of Proposition 8.** Since there are only to future states, let  $u$  denote the higher return

$$u = \max_{s^{t+1}|s^t} (q(s^{t+1}) + d(s_{t+1}))$$

and  $d$  denote the lower return

$$d = \min_{s^{t+1}|s^t} (q(s^{t+1}) + d(s_{t+1}))$$

We are considering the set of debt assets that promise 1 in both states and requires  $k$  unit of the real asset as collateral. The price of such an asset is  $p_k$

1.  $k < \frac{1}{u}$ ; then this asset is essentially the real asset because its effective pay-off is  $(ku, kd)$
2.  $\frac{1}{d} \geq k \geq \frac{1}{u}$ . Then the pay-off to the borrower of the asset is

$$(ku - 1, 0)$$

and he has to pay  $kq - p_k$ : she buys  $k$  real asset but she get  $p_k$  from selling the financial asset. So the borrowers only choose  $k$  such that

$$\frac{ku - 1}{kq - p_k}$$

is maximum among  $k \in [\frac{1}{u}, \frac{1}{d}]$ . So only assets belonging to

$$\arg \max_{k \in [\frac{1}{u}, \frac{1}{d}]} \frac{ku - 1}{kq - p_k} \tag{42}$$

will be chosen by borrowers in equilibrium.

Consider an actively traded financial asset with collateral level  $k^*$  belong to the argmax set above. If another asset with  $k < k^*$  is also actively traded, price of this asset,  $p_k$ , will be strictly less than

$$\frac{ku - 1}{k^*u - 1}p_{k^*} + \frac{k^* - k}{k^*u - 1}q.$$

Otherwise, due to collateral value of the real asset, buyers of this asset will strictly prefer the portfolio  $\frac{ku-1}{k^*u-1}$  of asset  $k^*$  and  $\frac{k^*-k}{k^*u-1}$  of the real asset. This portfolio gives the same payoff value as buying one unit of asset  $k$  as

$$\begin{bmatrix} 1 \\ kd \end{bmatrix} = \frac{ku - 1}{k^*u - 1} \begin{bmatrix} 1 \\ k^*d \end{bmatrix} + \frac{k^* - k}{k^*u - 1} \begin{bmatrix} u \\ d \end{bmatrix},$$

on top of that it gives the buyer an additional collateral value from holding the real asset.

Therefore

$$\frac{ku - 1}{kq - p_k} < \frac{k^*u - 1}{k^*q - p_{k^*}}.$$

Thus every seller of this asset  $k$  will strictly prefer selling asset  $k^*$ . ■

## References

- Alvarez, F. and U. J. Jermann (2000, July). Efficiency, equilibrium, and asset pricing with risk of default. *Econometrica* 68(4), 775–798.
- Alvarez, F. and U. J. Jermann (2001). Quantitative asset pricing implications of endogenous solvency constraints. *The Review of Financial Studies* 14(4), 1117–1151.
- Araujo, A., F. Kubler, and S. Schommer (2009). Regulating collateral requirements when markets are incomplete. Working Paper.
- Beker, P. and S. Chattopadhyay (2009). Consumption dynamics in general equilibrium: A characterisation when markets are incomplete. Working Paper, University of Warwick.
- Beker, P. and E. Espino (2010). A general equilibrium explanation for financial market anomalies: Belief heterogeneity under limited enforceability. University of Warwick Working Paper.
- Blume, L. and D. Easley (2006). If you’re so smart, why aren’t you rich? belief selection in complete and incomplete markets. *Econometrica* 74(4), 929–966.
- Chien, Y. and H. Lustig (2009). The market price of aggregate risk and the wealth distribution. *Review of Financial Studies*, forthcoming.
- Cogley, T. and T. Sargent (2008). Diverse beliefs, survival, and the market price of risk. Working Paper, NYU.
- Coury, T. and E. Sciuabba (2005). Belief heterogeneity and survival in incomplete markets. Working Paper, University of Oxford.
- Debreu, G. (1959). *Theory of Value*. John Wiley.
- Duffie, D., J. Geanakoplos, A. Mas-Colell, and A. McLennan (1994). Stationary markov equilibria. *Econometrica* 62(4), 745–781.
- Fostel, A. and J. Geanakoplos (2008). Leverage cycles and the anxious economy. *American Economic Reviews* 98(4), 1211–1244.
- Friedman, M. (1953). *Essays in Positive Economics*. University of Chicago Press.
- Geanakoplos, J. (2009). The leverage cycle. Cowles Foundation Discussion Paper.
- Geanakoplos, J. and H. Polemarchakis (1986). Existence, regularity, and constrained suboptimality of competitive allocations when the asset market is incomplete. In W. Heller, R. Starr, and D. Starrett (Eds.), *Essays in Honor of Kenneth Arrow*, Volume 3, pp. 65–95. Cambridge University Press.
- Geanakoplos, J. and W. Zame (2002). Collateral and the enforcement of intertemporal contracts. Discussion Paper, Yale University.
- Geanakoplos, J. and W. Zame (2007). Collateralized asset market. Discussion Paper, Yale University.
- Harrison, M. and D. Kreps (1978). Speculative investor behavior in a stock market with heterogeneous expectations. *Quarterly Journal of Economics* 92, 323–336.

- Kilenthong, W. T. (2009). Collateral premia and risk sharing under limited commitment. Working Paper, University of California, Santa Barbara.
- Kilenthong, W. T. and R. Townsend (2009). Market based, segregated exchanges in securities with default risk. Working Paper, MIT.
- Kiyotaki, N. and J. Moore (1997). Credit cycles. *Journal of Political Economy* 105(2), 211–248.
- Kogan, L., S. Ross, J. Wang, and M. Westerfield (2006). The price impact and survival of irrational traders. *Journal of Finance* 61, 195–229.
- Krusell, P. and J. Smith, Anthony A. (1998). Income and wealth heterogeneity in the macroeconomy. *The Journal of Political Economy* 106(5), 867–896.
- Kubler, F. and K. Schmedders (2003). Stationary equilibria in asset-pricing models with incomplete markets and collateral. *Econometrica* 71(6), 1767–1793.
- Long, J. B. D., A. Shleifer, L. H. Summers, and R. J. Waldmann (1990). Noise trader risk in financial markets. *The Journal of Political Economy* 98(4), 703–738.
- Long, J. B. D., A. Shleifer, L. H. Summers, and R. J. Waldmann (1991). The survival of noise traders in financial markets. *The Journal of Business* 64(1), 1–19.
- Lorenzoni, G. and K. Walentin (2009). Financial frictions, investment and tobin’s q. MIT Working Paper.
- Lucas, Robert E., J. (1978). Asset prices in an exchange economy. *Econometrica* 46(6), 1429–1445.
- Lucas, Robert E., J. and E. C. Prescott (1971). Investment under uncertainty. *Econometrica* 39(5), 659–681.
- Magill, M. and M. Quinzii (1994). Infinite horizon incomplete markets. *Econometrica* 62(4), 853–880.
- Miao, J. (2006). Competitive equilibria of economies with a continuum of consumers and aggregate shocks. *Journal of Economic Theory* 128, 274–298.
- Radner, R. (1972). Existence of equilibrium of plans, prices, and price expectations in a sequence of markets. *Econometrica* 40(2), 289–303.
- Sandroni, A. (2000, November). Do markets favor agents able to make accurate predictions? *Econometrica* 68(6), 1303–1342.
- Scheinkman, J. A. and W. Xiong (2003, December). Overconfidence and speculative bubbles. *Journal of Political Economy* 111(6), 1183–1219.
- Simsek, A. (2009a). Speculation and risk sharing with new financial assets. MIT Working Paper.
- Simsek, A. (2009b). When optimism needs credit: Asymmetric filtering of optimism and implications for asset prices. MIT Working Paper.
- Xiong, W. and H. Yan (2009). Heterogeneous expectations and bond markets. Cowles Foundation Discussion Paper.